

Printed Board Connectors – general information

Page

Creepage and clearance distances, CTI	00.04
Specifications, assembly instructions	00.06
System description	00.08
Male and female connectors with pcb fixings	00.12
Coding systems	00.14
NFF classification	00.17
Terminations	00.18

Extract DIN VDE 0110-04.97*)

This standard is a technical adaptation of IEC Report 664/664A and specifies, in general, the minimum insulation distances for equipment. It can be used by committees to protect persons and property in the best possible way from the effects of electrical voltages or currents (e.g. fire hazard) or from functional failure of the equipment by providing adequate dimensioning of clearances and creepage distances in equipment.

Rated impulse withstand voltage

In allocation of the equipment to an installation category, the following factors shall be taken into account:

- Overvoltages which can enter the equipment from outside across the terminals.
- Overvoltages generated in the equipment itself and occurring at the terminals.

The following parameters apply to:

Installation category I

Equipment is intended for use only in appliances or installation parts, in which no overvoltages can occur.

Equipment in this installation category is normally operated at extra low voltage.

Installation category II

Equipment is intended for use in installations or parts of installations, in which lightning overvoltages need not be considered. Overvoltages caused by switching must be taken into account.

This includes for example domestic appliances.

Installation category III

Equipment is intended for use in installations or parts of installations, in which lightning overvoltages need not be considered, but which are subject to particular requirements with regard to the safety and availability of the equipment and its supply systems.

This includes equipment for fixed installation such as protective devices, relays, switches and sockets.

Installation category IV

Equipment is intended for use in installations or parts of installations, in which lightning overvoltages must be taken into account.

This includes equipment for connection to overhead lines such as omnidirectional control receivers and meters.

For circuits or parts of circuits inside the equipment, clearances may be dimensioned directly for the expected overvoltages. If the expected overvoltages are not impulse voltages but DC or AC voltages, the maximum value of these voltages shall be determined as the rated impulse withstand voltage for clearances both for homogeneous and inhomogeneous field.

Degree of pollution

Pollution degree 1: No pollution or only dry, non-conductive pollution occurs. The pollution has no influence.

Pollution degree 2: Only non-conductive pollution occurs. A temporary conductive caused by condensation must be expected occasionally.

The degrees of pollution 3 and 4 are in this case not considered, as they are not relevant for the connectors shown in this catalogue.

Clearance

The clearance is defined as shortest distance through the air between two conductive elements.

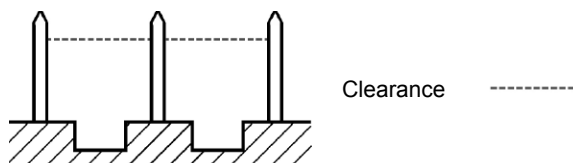

To identify the clearance distance

- Define the installation category
- Define the degree of pollution expected
- Select the rated impulse withstand voltage from table 00.01
- Select the minimum required clearance from table 00.02

Exemplary calculation

What voltage can be used, if the clearance, the installation category and the degree of pollution are known:

Clearance	Installation category	Degree of pollution	Voltage phase-to-earth
1.2 mm	II	2	150 V
3.0 mm	II	2	600 V
4.5 mm	II	2	600 V

Creepage

The creepage is defined as shortest distance on the surface of an insulating material between two conductive elements.

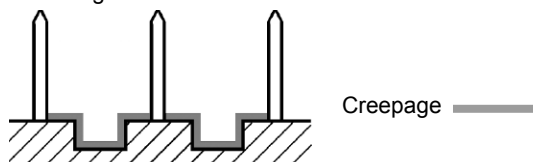

To identify the creepage distance

- Define the installation category
- Define the degree of pollution expected
- From the nominal voltage and the type of supply system select the rated voltage from table 00.03 a/b
- From the rated voltage and degree of pollution select the minimum creepage and CTI group of the connector required in table 00.04

For the dimensioning of the creepage distance the tracking formation of the insulating material has to be considered. If not indicated contrary, the CTI value of the insulating material is <400 and the isolation group is III a/b.

CTI (Comparative Tracking Index)

This figure gives an indication of the conductivity of insulating materials and affects the specified creepage distances. The influence of the CTI value on the creepage distance is as follows: the higher the index value, the shorter the creepage distance. The CTI is used to divide plastics into insulation groups.

Breakdown of insulation groups:

I	600 ≤ CTI
II	400 ≤ CTI < 600
IIIa	175 ≤ CTI < 400
IIIb	100 ≤ CTI < 175

*) It is the users responsibility to ensure that the complete current issue of the specification is considered.

Exemplary calculation
 What voltage can be used, if the creepage, the installation category and the degree of pollution are known:

Creepage	1.2 mm	3.0 mm	8.0 mm
Installation category	II	II	II
Degree of pollution	2	2	2
CTI-Value	< 400 > 400	< 400 > 400	< 400 > 400
Isolation group	III a/b II	III a/b II	III a/b II
Rated voltage	50 V 160 V	250V 400 V	800 V 1,000 V
Nominal voltage of supply system	50 V 150 V	220 V 380 V	720 V 1,000 V

How to identify the maximum voltage

1. Define the installation category
2. Define the degree of pollution expected
3. Select the rated impulse withstand voltage in kV from table 00.02
4. Select the voltage phase to earth derived from rated system voltages from table 00.01
5. Select the rated voltage from table 00.04
6. Define the number of phases and whether table 00.03 a or table 00.03 b is relevant for the application
7. Select the nominal voltage of supply system from table 00.03 a or 00.03 b
8. Select the lower voltage from point 4 and 7

Table 00.01

Voltages phase-to-earth derived from rated system voltages up to $U_{r.m.s.}$ and $U_$	Rated impulse withstand voltages in kV for installation category (Voltage form: 1.2/50 μ s according to DIN IEC 60060-1)			
	I	II	III	IV
50	0.33	0.50	0.80	1.5
100	0.50	0.80	1.5	2.5
150	0.80	1.5	2.5	4.0
300	1.5	2.5	4.0	6.0
600	2.5	4.0	6.0	8.0
1000	4.0	6.0	8.0	12.0

Table 00.02

Rated impulse withstand voltage in kV	Minimum clearances in mm up to 2000 m above sea level ¹⁾			
	Case A (Inhomogeneous field ³⁾)		Case B (Homogeneous field ²⁾)	
	Pollution degree		Pollution degree	
	1	2	1	2
0.33	0.01	0.2	0.01	0.2
0.50	0.04		0.04	
0.80	0.1		0.1	
1.5	0.5	0.5	0.3	0.3
2.5	1.5	1.5	0.6	0.6
4.0	3	3	1.2	1.2
6.0	5.5	5.5	2	2
8.0	8	8	3	3

¹⁾ For higher altitudes see table 2b from DIN VDE 0110 for multiplying factors.

²⁾ Verification by an impulse voltage test is required if the clearance is less than the value specified for case A.

³⁾ Point to plane.

Table 00.03 a. Single phase, three or two wire AC or DC systems

Table 00.03 b. Three phase, four or three wire AC systems

Nominal voltage of supply system ¹⁾ $U_{r.m.s.}$ or $U_$ in V	Rated voltage in V	
	Phase-to-phase All systems (between conductors of different polarity for $U_$)	Phase-to-earth
	$U_{r.m.s.}$ or $U_$	$U_{r.m.s.}$ or $U_$
12.5	12.5	–
24	25	–
25	–	–
30	32	–
42	–	–
48	50	–
50 ²⁾	–	–
60	63	–
60/30	63	32
100 ²⁾	100	–
110	125	–
120	–	–
150 ²⁾	160	–
220	250	–
220/110	250	125
240/120	–	–
300 ²⁾	320	–
440/220	500	250
600 ²⁾	630	–
480/960	1000	500
1000 ²⁾	1000	–

Nominal voltage of supply system ¹⁾ $U_{r.m.s.}$ in V	Rated voltage in V		
	Phase-to-phase	Phase-to-earth	
	$U_{r.m.s.}$	$U_{r.m.s.}$	$U_{r.m.s.}$
60	63	32	63
110	125	80	125
120	–	–	–
127	160	–	160
150 ²⁾	200	125	200
220	250	160	250
230	–	–	–
240	320	–	320
300 ²⁾	400	250	400
380	500	250	500
400	–	–	–
415	500	320	500
440	630	400	630
480	630	–	630
500	–	–	–
575	630	400	630
600 ²⁾	630	–	630
660	630	400	630
690	–	–	–
720	800	500	800
830	–	–	–
960	1000	630	1000
1000 ²⁾	1000	–	1000

¹⁾ This voltage can be the same as the rated voltage of the equipment.

²⁾ These values correspond to the values of table 00.01.

In countries where both star and delta, earthed and unearthed supply systems are used the values for delta systems only should be used. Systems earthed across impedances are treated as unearthed systems.

Table 00.04

Rated voltage (V) $U_{r.m.s.}$ or $U_$	12.5	25	32	50	63	80	100	125	160	200	250	320	400	500	630	800	1000
Minimum creepage distance (mm) Degree of pollution 1:																	
CTI group II + III a/b	0.09	0.125	0.14	0.18	0.2	0.22	0.25	0.28	0.32	0.42	0.56	0.75	1	1.3	1.8	2.4	3.2
Degree of pollution 2:																	
CTI group III a/b	0.42	0.5	0.53	1.2	1.25	1.3	1.4	1.5	1.6	2	2.5	3.2	4	5	6.3	8	10
CTI group II	0.42	0.5	0.53	0.85	0.9	0.95	1	1.05	1.1	1.4	1.8	2.2	2.8	3.5	4.5	5.6	7.1

Performance level 3 as per IEC 60 603-2

500 mating cycles then visual inspection.
 No gas test.
 No functional impairment.

Part number explanation 09 7 ..

Performance level 2 as per IEC 60 603-2

400 mating cycles.
 200 mating cycles then 4 days gas test using 10 ppm SO₂.
 Measurement of contact resistance.
 200 mating cycles then visual inspection. No abrasion of the contact finish through to the base material.
 No functional impairment.

Part number explanation 09 6 ..

Performance level 1 as per IEC 60 603-2

500 mating cycles.
 250 mating cycles then 10 days gas test using 10 ppm SO₂.
 Measurement of contact resistance.
 250 mating cycles then visual inspection. No abrasion of the contact finish through to the base material.
 No functional impairment.

Part number explanation 09 2 ..

Performance level 2 as per IEC 61 076-4-113

250 mating cycles.
 125 mating cycles then 4 days gas test using 10 ppm SO₂.
 Measurement of contact resistance.
 125 mating cycles then visual inspection. No abrasion of the contact finish through to the base material.
 No functional impairment.

Part number explanation 02 2 ..

Performance level 1 as per IEC 61 076-4-113

500 mating cycles.
 250 mating cycles then 10 days gas test using 10 ppm SO₂.
 Measurement of contact resistance.
 250 mating cycles then visual inspection. No abrasion of the contact finish through to the base material.
 No functional impairment.

Part number explanation 02 1 ..

In the industry DIN connectors in performance level 2 are specified most frequently. Connectors in performance level 1 are used for higher requirements, e.g. in railway applications.

Other plating finishes available on request.

Mating conditions

To ensure reliable connections and prevent unnecessary damage, please refer to the application data diagrams.

These recommendations are set out in IEC 60 603-2.

The connectors should not be coupled and decoupled under electrical load.

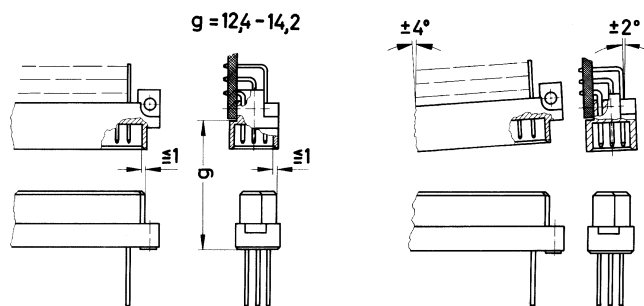

Soldering the male connectors into pcb's

Male connectors should be protected when being soldered in a dip, flow or film soldering baths. Otherwise, they might become contaminated as a result of soldering operations or deformed as a result of overheating.

- ① For prototypes and short runs protect the connectors with an industrial adhesive tape, e.g. Tesaband 4331 (www.tesa.de). Cover the underside of the connector moulding and the adjacent parts of the pcb as well as the open sides of the connector. This will prevent heat and gases of the soldering apparatus from damaging the connector. About 140 + 5 mm of the tape should suffice.
- ② For large series a jig is recommended. Its protective cover with a fast action mechanical locking device shields the connectors from gas and heat generated by the soldering apparatus. As an additional protection a foil can be used for covering the parts that should not be soldered.
- ③ For prototypes and short runs the protection described under point ① can be replaced by a solder protection cap. This cap can be ordered under the part no. 09 02 000 9935.



Adhesive tape or protection cap

① + ③

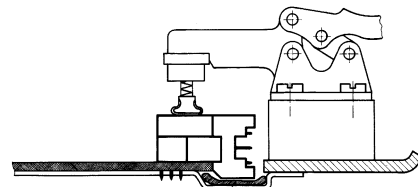

Intermediate foil

②

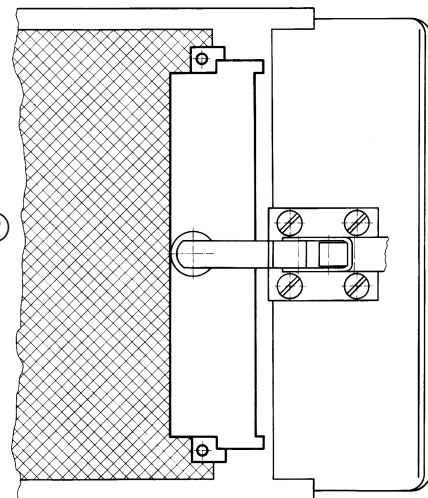

Design of connectors

- Standard fixing arrangement
- Standard positions for pcb's and connectors provide a modular system in the card frame and a standard front panel system.
- Standard wiring matrix on the connection side for female connectors built up on a 2.54 mm (0.1" centres) grid. (This facilitates automatic wiring).
- Printed circuit boards with standard dimensions 100 x 160 resp. 233.4 x 160 mm as set out in DIN EN 60 297-3 standard sizes 3 U and 6 U.

Building up card frame systems

In the basic frame unit according to DIN EN 60 297-3 pcb's are inserted from the front and make contact with the connectors fitted to the back. This basic arrangement gives the following advantages:

- When using conventional connectors on the back of the card frames, space is left above, below and in the middle along the horizontal line of the frame which can be used to fit extra connectors for cross connection or making plug connections by means of flying lead connectors.
- Using the HARTING system one can also connect flying lead connectors onto the front of the frame or even onto the inside of the back of the frame. This means that external equipment can easily be monitored, controlled or tested from the card frame itself.

Complementary components

All connectors can be supplied with a complete range of accessories. These can be fitted above or below the wiring plane on the back of the card frame or on the front of the card frame. These connectors and accessories provide a complete connector system suitable for commonly used wiring techniques.

- The flying lead connector consists of a connector with crimp or solder contacts and a shell housing. The flying lead connector is latched or retained in position using screw fixings and is compatible with a corresponding male connector and interface connector I.
- Fixing brackets prohibit the withdrawal of the pcb when a flying lead connector is used on the front side of the card frame.
- The interface connector I has blade contacts on the plug side and solder pins, wrap posts or crimp terminals on the termination side. It replaces the female connector type F fitted into the frame and allows interfacing to the internal wiring with the help of the flying lead connector on the back of the card frame unit.

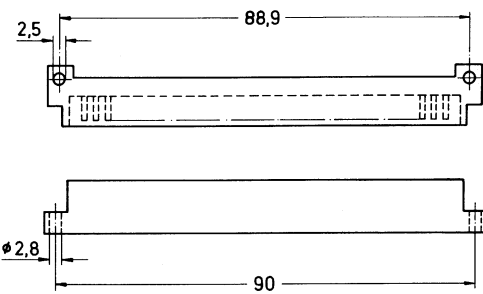



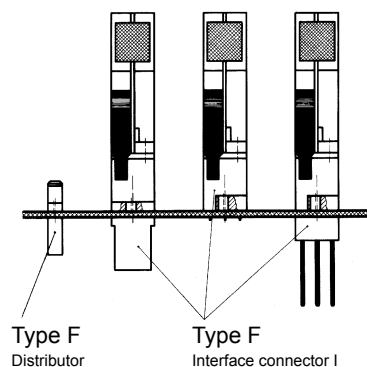
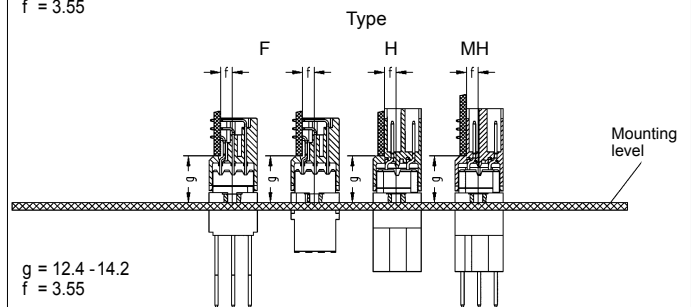
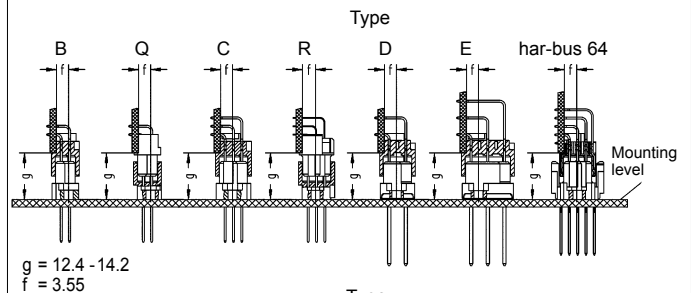
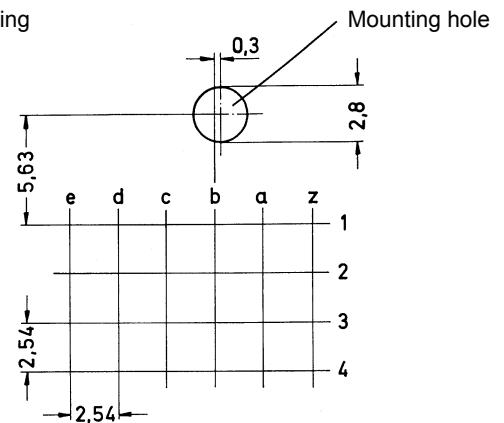





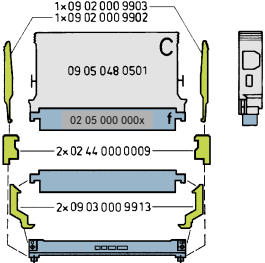
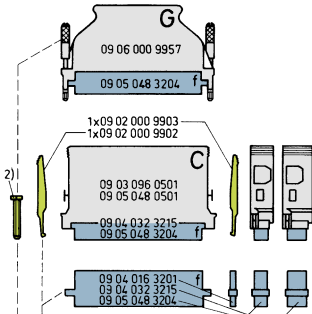
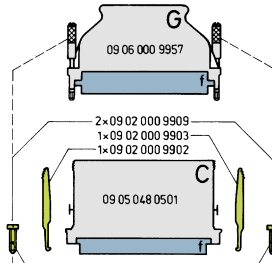



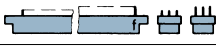



Contact spacing



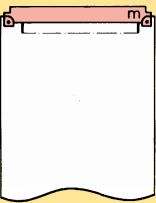
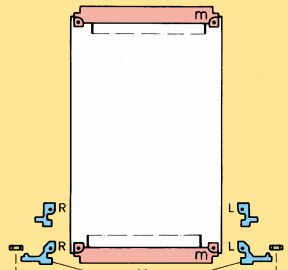
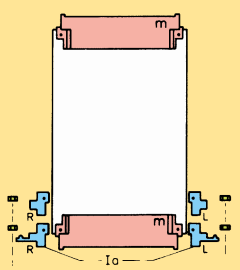

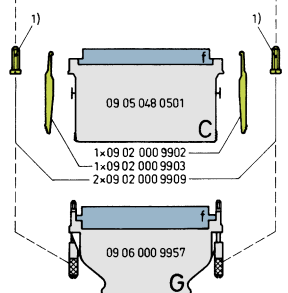
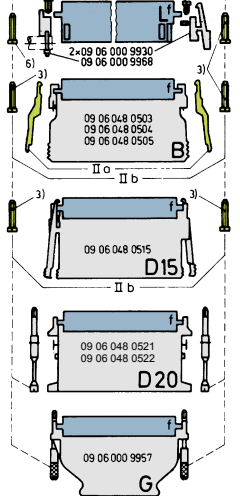
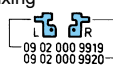
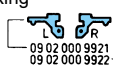

General information

Type	B, Q	C, R	D
Wiring side (Rear side)	Input access from the front side via a female connector	Input access via a female connector	Input access from the front side via a female connector
		Pin shroud 	Piggyback connector
Soldering technique for a flexible wiring			
Soldering technique for pcb Press-in technique for pcb			
Crimp connections			
Wrapped connections posts 0.6 x 0.6 mm 1 x 1 mm			
Middle section 			
Front side 			
<p>1) Screw fixing (cheesehead screw M 2.5 x 16 + nut) 09 02 000 9909</p> <p>2) 2 x screw fixing (cylindric screw M 2.5 x 25 DIN EN ISO 1207 + nut M 2.5 DIN EN ISO 4032)</p> <p>3) Fixing brackets for latching and screw fixing</p> <p>4) Screw length depends on the pcb thickness</p>			
<p>f = female connector m = male connector R = right hand L = left hand</p>			

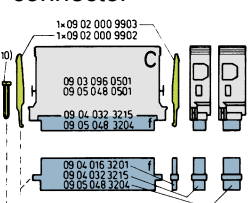
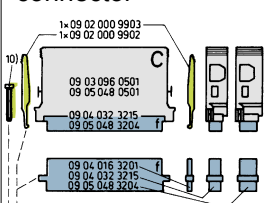
<i>harbus</i> [®] 64	E		H
<p>Input access from the front side via a female connector</p> 	<p>Input access via a female connector</p> <p>Piggyback connector</p> 		<p>Input access from the front side via a female connector</p> 
			
			
			
	<p>1 x 1 mm</p> 		
			
			
<p>Y =</p>	<p>Combinations</p>	<p>Fixing bracket c for male connectors</p> <p>Multiple fixing</p>  <p>Single fixing</p> 	<p>l element</p> 
<p>Housing C</p>	<p>latchable</p>	<p>latch and screw fixing (M 2.5 x 16)</p>	<p>latch and screw fixing</p>
<p>Housing G</p>		<p>screw fixing</p>	<p>screw fixing</p>

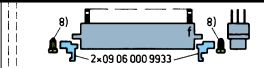
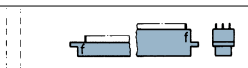
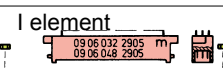
General information

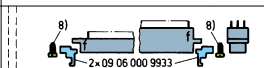
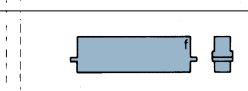
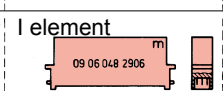
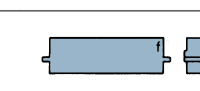
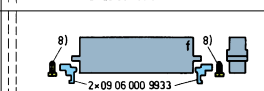
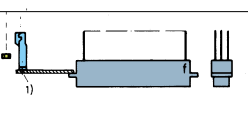
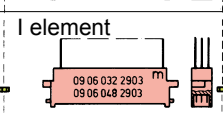
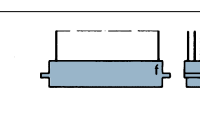
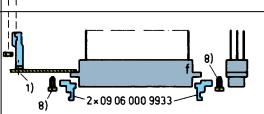
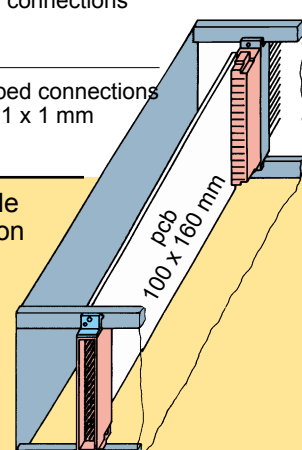
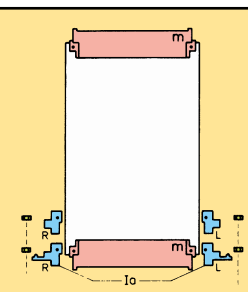
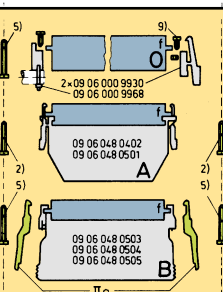
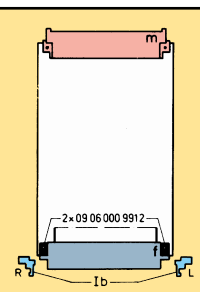
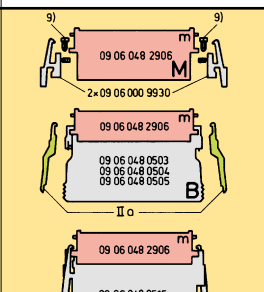
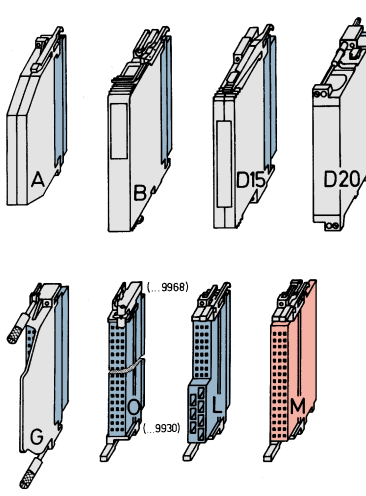
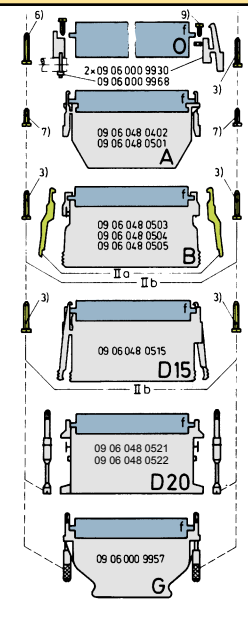
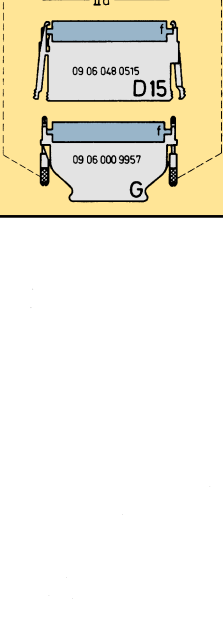
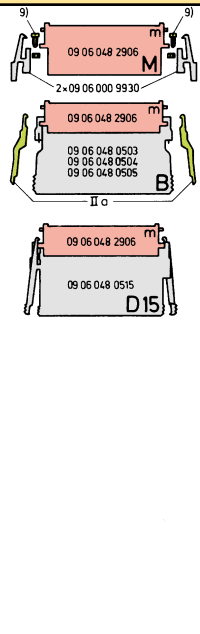
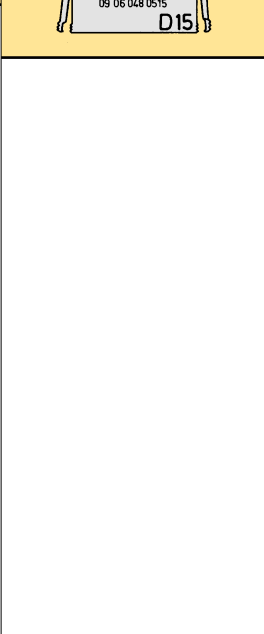
Type	F			
Wiring side (Rear side)	Input access via a female connector Piggyback connector 		Output from the front side via a male connector Piggyback connector 	
Soldering technique for a flexible wiring				
Soldering technique for pcb Press-in technique for pcb		I element 		
Crimp connections		I element 		
Wrapped connections posts 1 x 1 mm		I element 		
Middle section 		I element 		
Front side 				

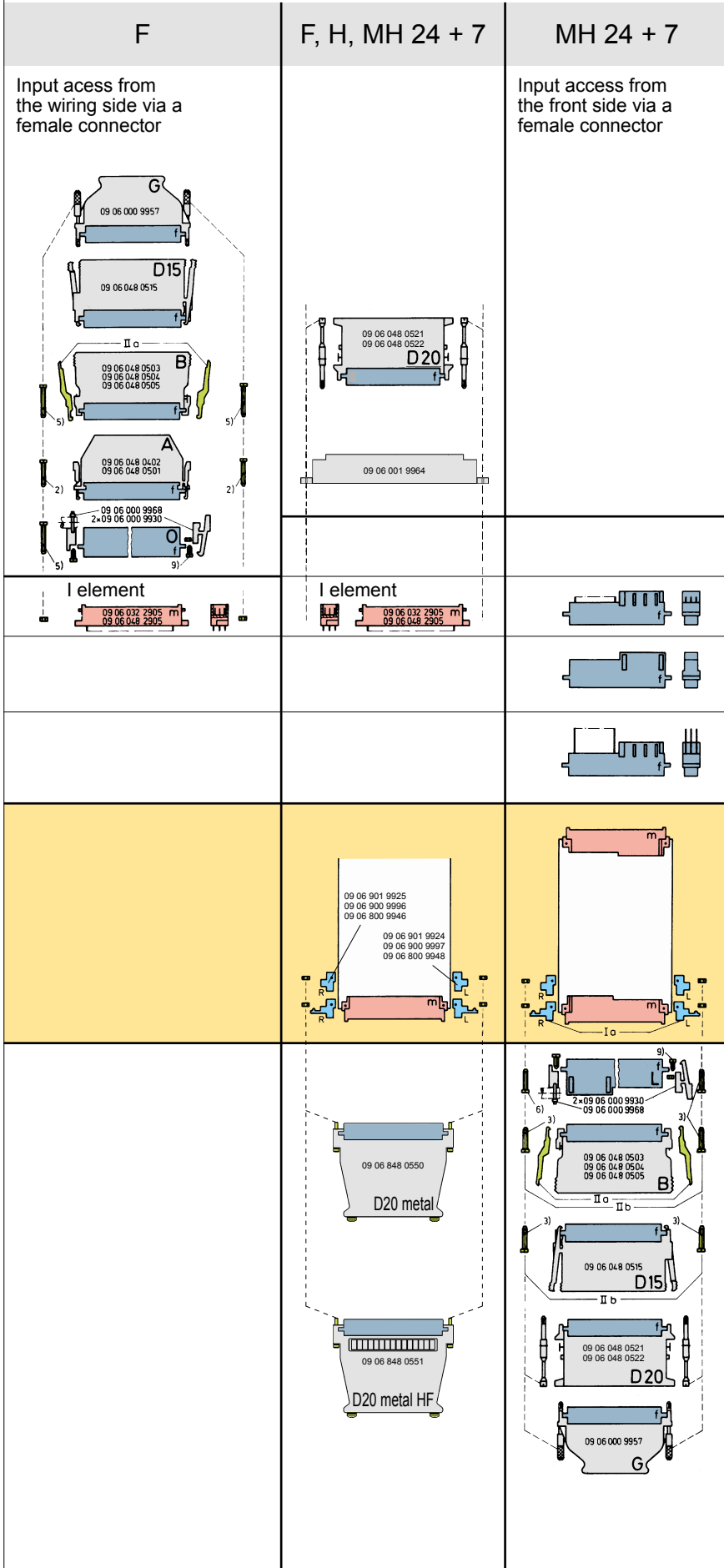

Ia				
Combinations	Fixing bracket a for male connectors		Fixing bracket b for male connectors	
	Multiple fixing	Single fixing	Multiple fixing	Single fixing
Housing A	latch (M 2.5 x 12) and screw fixing		latchable	
Housing B			latch (M 2.5 x 20) and screw fixing	
Housing D15			latch (M 2.5 x 20) and screw fixing	
Housing D20			screw fixing	
Housing G			screw fixing	
(...9930)			latch (M 2.5 x 20) and screw fixing	
Comb. O (...9968)			screw fixing	
(...9930)			latch (M 2.5 x 20) and screw fixing	
Comb. L (...9968)			screw fixing	
Ib				
Combinations	Fixing bracket b for female connectors		I element	
	Multiple fixing			
Housing A			(M 2.5x22) latch and (M 2.5x16) screw fixing	
Housing B	latchable		(M 2.5x26) latch and (M 2.5x20) screw fixing	
Housing D15	latchable		latchable	
Housing G			screw fixing	
(...9930)			latchable	
Comb. O (...9968)			(M 2.5x26) screw fixing (M 2.5x20)	
Comb. M	latchable			
II				
Housing B/D 15	II a		II b	
09 06 048 0503	2x	09 06 000 9913	and/or 2x	09 06 000 9926
09 06 048 0504	1x	{ 09 06 000 9913 09 06 000 9919	and/or 2x	09 06 000 9926
09 06 048 0505	1x	{ 09 06 000 9913 09 06 000 9919	and/or 2x	09 06 000 9926
09 06 048 0515	-	-	and 2x	09 06 000 9926
Comb. O + L	2x 2x	09 06 000 9930 09 06 000 9968	and 2x	09 06 000 9926
Comb. M	2x	09 06 000 9930	-	-

- 1) Fixing brackets for latch and screw fixing
 - 2) Screw M 2.5 x 22 belongs to supply of I elements, nut M 2.5 DIN EN ISO 4036 does not belong to scope of supply
 - 3) Screw fixing (cheesehead screw M 2.5 x 20 + nut) 09 06 000 9926
 - 4) Screw fixing (cheesehead screw M 2.5 x 16 + nut) 09 02 000 9909
 - 5) Cheesehead screw (M 2.5 x 26) 09 06 000 9955, nut M 2.5 DIN EN ISO 4036 does not belong to scope of supply
 - 6) Screw M 2.5 x 20 belongs to the junction element, hexagonal nut M 2.5 DIN EN ISO 4036 does not belong to scope of supply
- Following items don't belong to scope of supply**
- 7) Screw M 2.5 x 12 and nut M 2.5 DIN EN ISO 4036
 - 8) Screw M 2.5 x 8
 - 9) Screw M 2.5 x 8 and nut M 2.5 DIN EN 4 032
 - 10) Screw M 2.5 x 25 and nut M 2.5 DIN EN 4 032
- f** = female connector
m = male connector
R = right hand
L = left hand

The automated insertion of components into pcb's is increasing.

To meet this market demand, HARTING has developed connectors which can be assembled and fixed to the pcb in one process.

To fix the connectors HARTING offers snap-in clips as well as kinked pins.

Snap-in clips

In the soldering process, all component terminations including the snap-in clips are soldered and therefore mechanically secured. This provides mechanical protection for the soldered contacts during mating and unmating of the connector.

Mouldings with snap-in clips offer the following advantages:

- Cost reduction when compared with the screw or rivet assembly methods due to the soldering of the clip along with other components in one process.
- The orientation of the clip **after soldering in the plated through hole** provides mechanical protection against the tensile forces arising from the mating and unmating of the connector.

It is possible to supply the majority of male and female connectors with solder termination with snap-in clips (existing articles see product pages).

For pcb thickness
 $1.6 \pm 0.2 \text{ mm}$
 $\varnothing = 2.8^{+0.1} \text{ mm}$

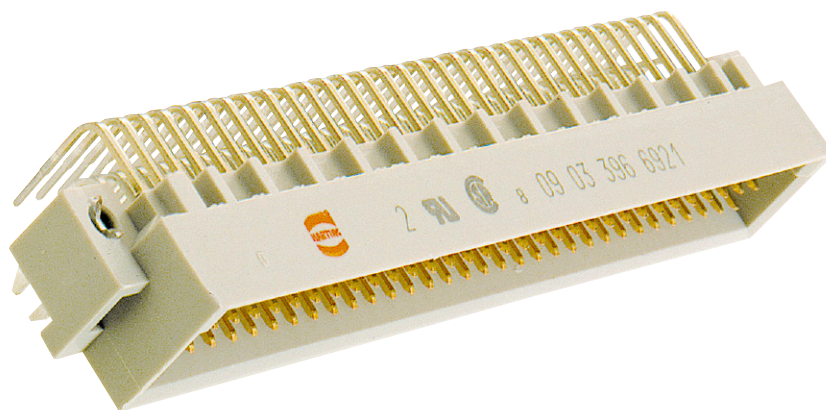

Mounting force
 40 - 60 N

For pcb thickness
 $1.6 - 4.0 \text{ mm}$
 $\varnothing = 2.8^{+0.1} \text{ mm}$

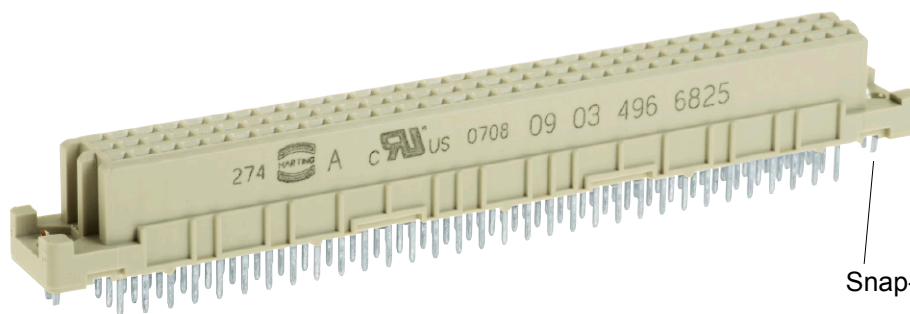

Snap-in clip

Kinked pins

Before and during soldering, the connectors are fixed onto the pcb with four kinked contacts located in the rows a and c, e.g. the positions a1, c1, a32 and c32 for a fully loaded connector.

Connectors with kinked pins are a reliable alternative for female connectors with straight terminations because no additional elements like screws, rivets or clips are necessary.

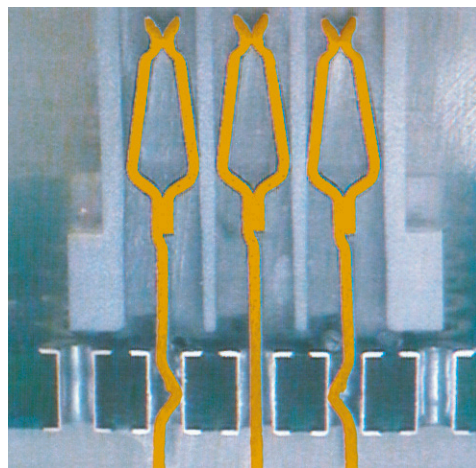
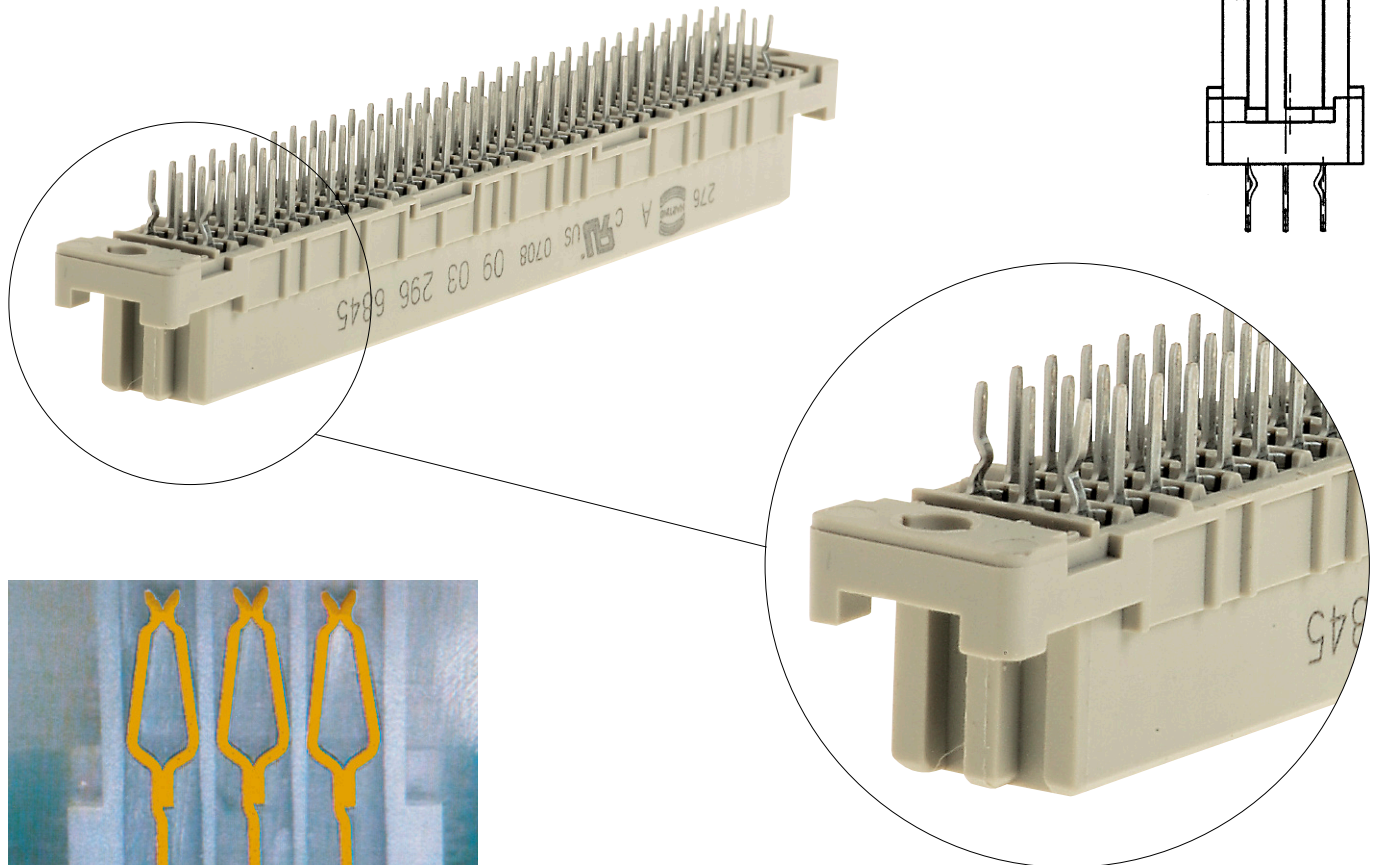

Connectors see chapter 01, type C.





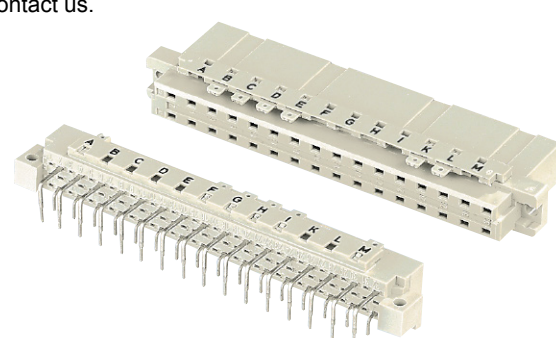

Cross section of a connector with kinked contacts assembled to a pcb

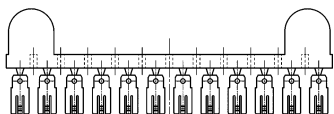
Dimension of the plated through hole [mm]	Mounting force [N]	Retention force [N] before soldering
0.94	55	35
1.09	11	7

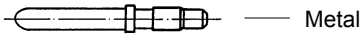
Typical measurements for a pcb of 2.4 mm thickness.

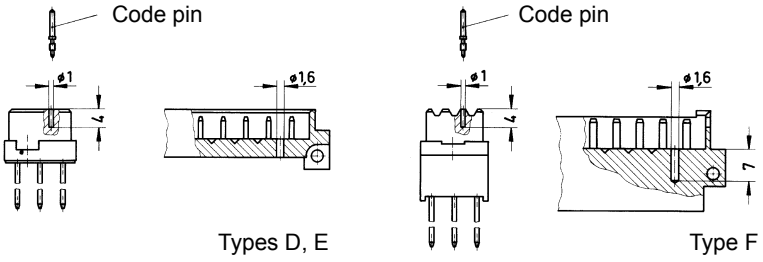
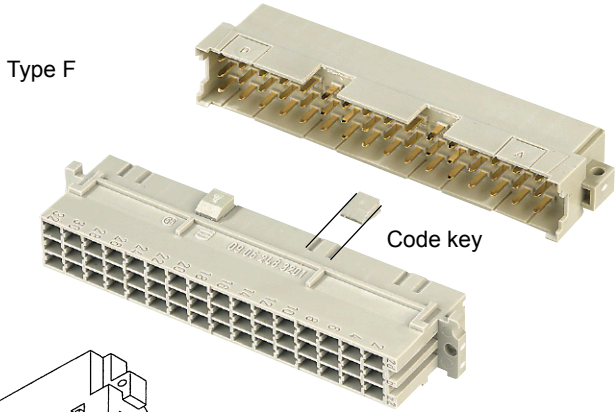
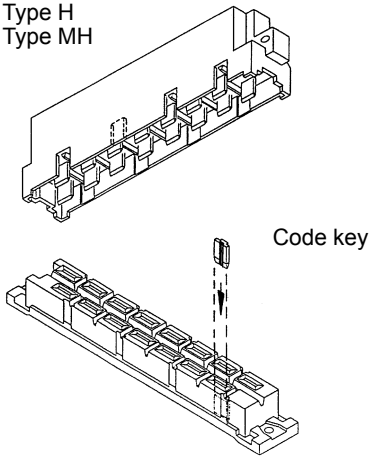
Identification	Part number	Drawing	Dimensions in mm
<p>Coding system <u>without</u> contact loss – side coding</p>	<p>Male and female connectors</p> <p>Types B, C, D, E and R</p> <p>see product pages or on request</p>	<p>To avoid accidental and incorrect mating of adjacent connectors a coding system is required. This coding system is an integral part of both male and female connectors. A comb with 12 coding pins, which is supplied under a single part number, allows over 900 coding variations. The pins are to be locked into the male and female connectors.</p> <p>The connectors with the integrated coding facility are supplied for types B, C, D, E and R and are available for all variants.</p> <p>Please contact us.</p>	
<p>Coding system <u>without</u> contact loss – side coding</p> <p>Coding bar for screw fixing</p> <p>for types C and D male connectors for type R female connectors</p> <p>for type B male connectors for type Q female connectors</p> <p>for type E male connectors</p>	<p>09 73 000 9903</p> <p>09 72 000 9903</p> <p>09 05 000 9903</p>	<p>These coding bars can be screwed on the top side of angled male and female connectors. They are alternatives to the male and female connectors with pre-assembled or splashed coding bars. As far as available we recommend the connectors with pre-assembled or splashed coding bar.</p>	
<p>Coding pins</p> <p>12 pins on a comb</p> <p>09 02 000 9928</p> <p>Mounting example</p>		 <p>Type</p> <p>B C D D E E</p> <p>12,7 15,24 15,24 15,24 20,32</p> <p>27</p> <p>39</p> <p>4 6</p> <p>11 x 6 = 66</p>	

Identification	Part number	Drawing	Dimensions in mm
<p>Coding system <u>without</u> contact loss</p> <p>with code pin</p> <p>Code pin 09 06 000 9950</p> <p>Insertion tool 09 99 000 0103</p> <p>shroud coding Type F</p> <p>Code key 09 06 001 9919</p> <p>shroud coding Types H, MH 24 + 7</p> <p>Code key 09 06 001 9918</p>		<p>With the aid of the marked indents between the contact rows of the male connector a hole has to be drilled at the desired position (also see drawing). The code pin can then be inserted into the corresponding cavity of the female connector by means of the insertion tool.</p> <p>This coding system is available only for the types D, E, F and interface connectors I.</p>  <p>— Metal</p>  <p>Mounting example</p>  <p>Types D, E</p> <p>Type F</p> <p>Insert the code key into one of the keyways of the female connector as shown in the drawing. Break out the corresponding area of the male shroud. Connectors coded this way can only be applied in a minimum rack spacing of 20.32 mm.</p>  <p>Type F</p> <p>Code key</p>  <p>Type H Type MH</p> <p>Code key</p>	
<p>Tool for breaking out the coding area of the male shroud</p>	<p>09 99 000 0242</p>		

Identification	Part number	Drawing	Dimensions in mm
<p>Coding system <u>without</u> contact loss</p> <p>flange coding</p> <p>Type MH 21 + 5</p> <p>colour red blue green orange</p> <p>colour red blue green orange</p>	<p>Code keys</p> <p>for male connectors</p> <p>09 06 001 9950 09 06 001 9951 09 06 001 9952 09 06 001 9953</p> <p>for female connectors</p> <p>09 06 001 9960 09 06 001 9961 09 06 001 9962 09 06 001 9963</p>	<p>can be mounted with a screwdriver (max. width 3 mm)</p>	
<p>Coding system <u>with</u> contact loss</p>	<p>Code pin for types B, 2B, 3B, C, 2C, 3C, M, M-flat, Q, 2Q, R, R (HE 11), 2R, har-bus 64</p> <p>09 02 000 9901</p> <p>Removal tool for male contacts</p> <p>09 99 000 0133</p> <p>Code pin for types D, E, F, FM, 2F, MH</p> <p>09 04 000 9908</p> <p>Removal tool for male contacts</p> <p>09 99 000 0038</p>	<p>To avoid accidental and incorrect mating of adjacent connectors a coding system is required. The coding is achieved by means of a code pin which is inserted into the selected chamber of the female connector (the contact cavity must be filled with a female contact!). The opposite male contact must be removed with the help of the specially designed tool.</p> <p>It's recommended to use a number of code pins in relation to the total number of contacts per connector: 3 pins for 64 contacts, 7 pins for 160 contacts.</p> <p>Plastic, grey</p> <p>Plastic, black</p>	

In addition to the standard demands of connectors, as defined in IEC 60 603-2, for example, market and application specific demands and requirements are gaining increasing significance.

In the railway engineering area the demands made on reliability and safety are particularly high, in order to ensure utmost passenger safety in all instances. Especially in the case of routes involving a high share of tunnels that only offer limited escape route possibilities in the event of fire, the technical demands made on the materials employed are very stringent.

In addition to the fire load, and/or the flammability of a material, the so-called smoke gas density is a key characteristic, which is determined based on the opacity and toxicity of the smoke gas emissions. The risk posed by the two characteristics can not be defined in relationship to each other, which means that both minimal inflammability as well as minimal smoke gas density must be fulfilled. Materials that meet both requirements are very rare and in many instances it is only possible to fully meet one of the two criteria.

The French NFF 16-101 railway standard defines these requirements precisely and presents a structure of application groups by way of a matrix.

NFF 16-101 classifies non-metallic materials used in rail vehicles in terms of fire behavior, opacity and toxicity of smoke gas emissions in the event that the materials should burn.

In order to enable the classification with regard to the deployment of connectors, the following values must be applied:

1. Fire behavior class

Classification:

I0	for I.O. ≥ 70	and no inflammation at 960 °C
I1	for I.O. 45 - 69	and no inflammation at 960 °C
I2	for I.O. 32 - 44	and no inflammation at 850 °C
I3	for I.O. 28 - 31	and no afterburning at 850 °C
I4	for I.O. ≥ 20	
NC	not classified	

Note: The values are derived from specified test methods determining the oxygen value (I.O.) and testing inflammability by way of a filament.

2. Smoke development classification

Classification:

F0	for I.F. ≤ 5
F1	for I.F. 6 - 20
F2	for I.F. 21 - 40
F3	for I.F. 41 - 80
F4	for I.F. 81 - 120
F5	for I.F. > 120

Note: The values of the smoke index (I.F.) are derived from specified test methods by determining opacity (specific optical density, opacity values), toxicity (critical gas concentration of CO, CO₂, HCl, HBr, HCN, HF, SO₂ in smoke).

The matrix from NFF 16-102 shows how the combination of both characteristics results in a classification. This matrix is defined by the contractor in each project put up for bidding. The matrix is geared to the type of train and course of the route, whereby special attention is given to the number of tunnels. By complying with the high classifications I2 and F1, the designated standards supplementing connectors according to IEC 60603-2 can be used in all four defined groups and for all railway applications. According to NFF 16-102 the standard DIN connectors (I3, F4) are only permissible for Group 1.

Group 1							Group 2						
	I0	I1	I2	I3	I4	NC		I0	I1	I2	I3	I4	NC
F0	Green	Green	Green	Green	Green	Red	F0	Green	Green	Green	Green	Green	Red
F1	Green	Green	X	Green	Green	Red	F1	Green	Green	X	Green	Green	Red
F2	Green	Green	Green	Green	Green	Red	F2	Green	Green	Green	Green	Green	Red
F3	Green	Green	Green	Green	Green	Red	F3	Green	Green	Green	Green	Green	Red
F4	Green	Green	Green	Green	Green	Red	F4	Green	Green	Green	Green	Green	Red
F5	Red	Red	Red	Red	Red	Red	F5	Green	Green	Green	Green	Green	Red

Group 3							Group 4						
	I0	I1	I2	I3	I4	NC		I0	I1	I2	I3	I4	NC
F0	Green	Green	Green	Green	Green	Red	F0	Green	Green	Green	Green	Green	Red
F1	Green	Green	X	Green	Green	Red	F1	Green	Green	X	Green	Green	Red
F2	Green	Green	Green	Green	Green	Red	F2	Green	Green	Green	Green	Green	Red
F3	Green	Green	Green	Green	Green	Red	F3	Green	Green	Green	Green	Green	Red
F4	Green	Green	Green	Green	Green	Red	F4	Green	Green	Green	Green	Green	Red
F5	Green	Red	Red	Red	Red	Red	F5	Green	Green	Green	Green	Green	Red

Diagram: Classification from NFF 16-102, April 1992

The HARTING DIN Power and DIN Signal portfolio looks back on a highly successful track record in the railroad engineering industry. Typical application areas include – among many others – control, steering, monitoring components and modules on board trains, as well as signal technology components or the power supply of electronic components.

The extended range of connectors complying with the highest classification according to NFF 16-101 and 16-102 considerably reduces our customers' development times: as the selected connectors are suitable for every stipulated hazard or risk class, they are ideal for realizing product platforms, and therefore find use in every conceivable rail vehicle or railroad engineering project. This dispenses with the need for complex, product specific development work, at least in terms of selecting passive PCB interfaces, while the technical approval process is streamlined considerably.

In order to facilitate rapid identification, the additional railway specific articles are designated accordingly on the product pages of this catalogue.

Since 2013 the current European flammability directive is EN 45545:2013. After a transition period, this will replace the national standards, for example NFF 16-101 / 102.

Small electronic components are listed in the standard under "EL10". This includes the DIN 41612 connectors according to IEC 60603-2 shown in this catalogue. For these components it's required to provide evidence that the criterion "V0" in compliance with EN 60695-11-10 or UL 94 has been met to comply with the defined requirement paragraph R26.

For flammable materials with the mass under 10 g no evidence must be provided. The so-called grouping rule encompasses flammable and non-tested materials which lie closer than 20 mm in the vertical direction and 200 mm in the horizontal direction to each other. Due to this rule, the limit value can be increased to 100 g for the internal area and 400 g for the external area of the vehicle.

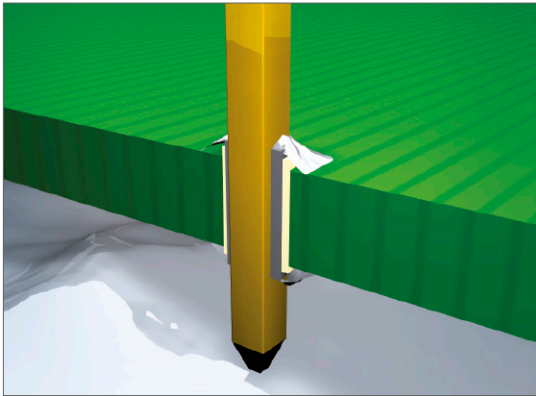

THT soldering technology

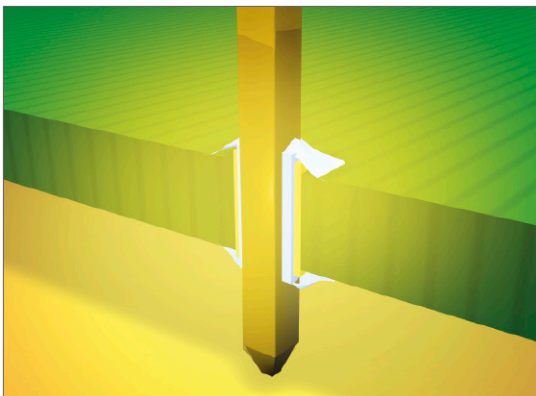

THR soldering technology

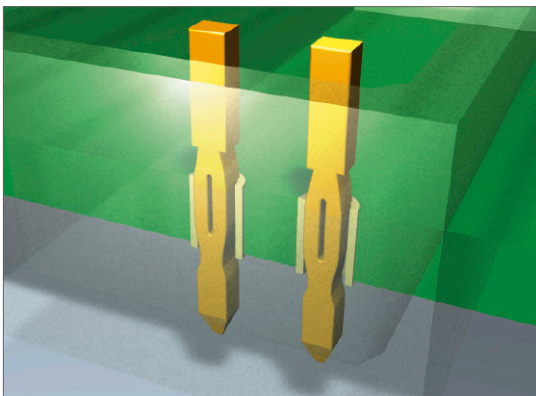

Press-in technology

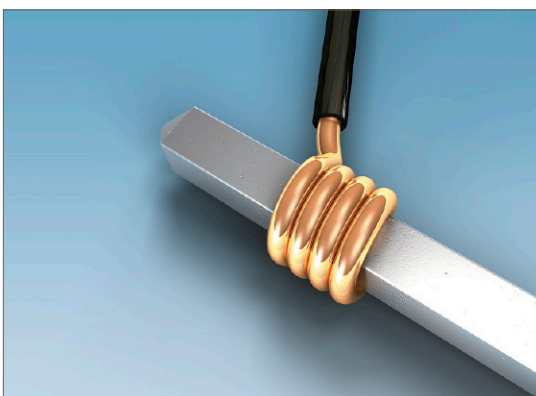

Wire wrap terminals

THT soldering technology

Proven over decades, standard soldering technologies deliver maximum stability and process reliability. The soldering pins of the connectors are inserted into the through-plated PCB holes and can then be soldered simultaneously with other components in a wave soldering process.

THR soldering technology

The connector is inserted into through-plated PCB holes similar to standard component assembly for processing with THR (Through Hole Reflow) soldering technology. Insertion of these SMT components can be automated by means of Pick & Place assembly in preparation for a reflow soldering process together with the surface-mounted component.

This connection technology is characterized by high mechanical strength and is facilitated by a design that is specially adapted to the reflow soldering process (high-temperature materials).

Press-in technology

This solder-free connection technology is based on press-in mounting of a pin in a throughplated PCB hole. The implementation of a state-of-the-art, flexible press-fit zone allows for the compensation of tolerances of PCB holes and meets high electrical and mechanical requirements for properties such as low press-in forces and high holding forces.

Press-in technology supports unlimited cost efficient processing, especially of pins with selective gold plating for backplane bus systems.

Wire wrap terminals

This solder-free connection technology is based on a wire, which is wrapped with several turns onto a rectangular post. When wires are correctly wrapped the connection performs with low resistance, mechanical strength and high reliability, unaffected by normal climatic or temperature change.

Crimp terminals

Gas-proof and the miniaturized contact technology are synonymous with crimp technology. The flexible conductor is inserted into the crimp contact and is retained by controlled deformation. This technology is similar to a cold welding process and provides maximum aging resistance and mechanical resistance to shock and vibration. Crimp machines facilitate the efficient, streamlined production of system cable assemblies, and crimp technology can also be deployed for field assemblies using the corresponding hand crimp tools. The technical requirements for crimp technology are standardized in IEC 60 352-2.

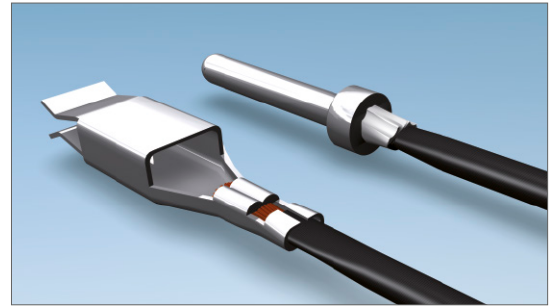

Crimp terminal

IDC insulation displacement terminals

IDC (insulation displacement contact) technology facilitates the simple and safe termination of solid and flexible conductors. With IDC technology, a blade cuts through the wire insulation and produces an elastic termination in a single pass. This gas-proof connection provides maximum safety even for the lowest currents and voltages. Technical requirements for IDC technology are standardized in IEC 60 352-3.

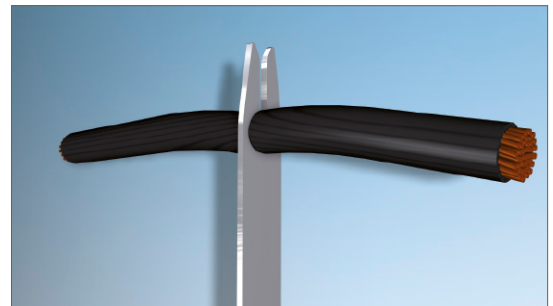

IDC insulation displacement terminals

Solder lug terminals

The solder lug termination is the optimized solution for production of small lot sizes and prototypes. Even without any special tooling a big variety of cables can be terminated to the cable connectors. The stripped wire is soldered individually by hand to the solder lug. This termination should however only be manufactured by experienced specialists.

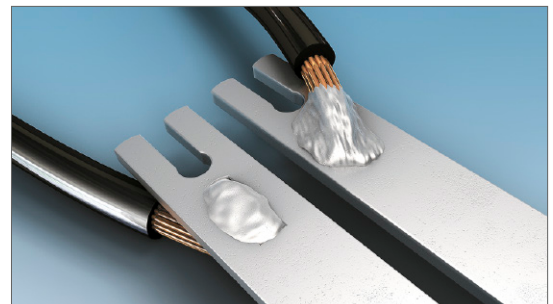

Solder lug terminals

Faston blades terminals

The faston blade termination is used for free wiring. Benefits are the high current carrying capacity (up to 15 A) and the easy possibility for variations.



Faston blades terminals

Cage clamp terminals

The cage clamp terminal technology is used to terminate flexible and solid conductors by means of spring force. After the spring has been opened by an actuator element, the stripped conductor is simply inserted into the contact chamber. This connection technology requires minimum operating expense and is characterized by its high functional safety. The springloaded connection also allows the termination of more than one wire per contact and excels with high vibration and shock resistance.



Cage clamp terminals

THT soldering technology

The term "soldering" is defined in DIN 8505:

"Soldering is a method of connecting metallic materials using an additional melting metal, if necessary with the assistance of a flux and/or protective gas. The melting temperature of the solder must lie beneath the minimum melting temperature of the base metals being connected. These base metals shall be tinned without melting themselves."

Soft solders commonly used on electronic equipment are to DIN 1707-100. Today's lead free solders have a melting range between 217 °C and 227 °C depending on the composition of the alloy. For soldering metallic materials the flux is defined in DIN EN 29454-1. Tests are explained in DIN 8526. For soldering male connectors into printed circuit boards, see recommendations for soldering on page 00.06.

THR soldering technology

The continuing trend towards miniaturisation has revolutionised the assembly of electronic components. For the past 15 years, most components have been secured directly to the pcb surface by means of Surface Mount Technology (SMT). By dispensing with drilled holes on the pcb, a space saving of up to 70 percent is achieved.

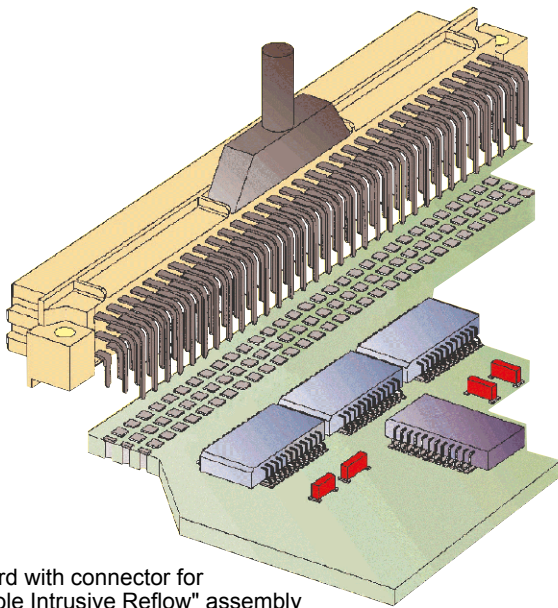

Fig. 1: SMT board with connector for "Pin in Hole Intrusive Reflow" assembly

Today, typical components such as resistors, ICs, capacitors, and connectors with straight terminal pins are almost exclusively fitted using SMD (Surface Mount Device) technology in mass production. In contrast, angled SMD connectors at the edge of the board have not been successful because of tolerance problems (co-planarity) and stresses during mating. Modified solder connectors for assembly with "Pin in Hole Intrusive Reflow" process offer a better solution. These can be mounted at low cost, utilising existing SMD production lines.

"Pin in Hole Intrusive Reflow"

In this process, the connector is inserted into plated through holes in a comparable way to conventional component mounting. All other components can be assembled on the pcb surface.

The components are positioned using pick-and-place machines. These automatic assembly machines differ according to whether the components are small, lightweight or bulky. Connectors are considered bulky (odd form) because of their comparatively heavy weight and large volume which makes them more difficult to grip. Furthermore, machines for odd form components must have higher insertion power to fit the components into pcb holes, which are filled with solder paste. As a rule, modern THR production lines are equipped with both types of machine, therefore the "Pin in Hole Intrusive Reflow" process generally entails no extra investment costs for the user.

Conventional assembly process:

1. Application of solder paste
2. Positioning the components
3. Positioning odd form components
4. Reflow soldering
5. Pressing in or partially dip soldering the connector at the board edge
6. Quality inspection

"Pin in Hole Intrusive Reflow" assembly:

1. Application of solder paste
2. Positioning the components
3. Positioning odd form components
4. Reflow soldering
- ~~5. Pressing in or partially dip soldering the connector at the board edge~~
6. Quality inspection

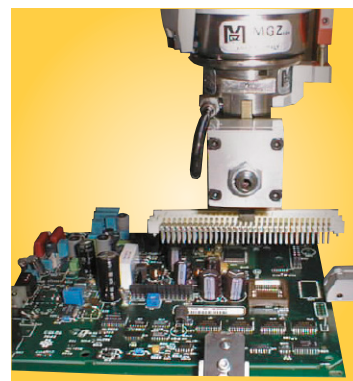

Fig. 2: Pick-and-place machine for odd form components (Courtesy of JOT Automation GmbH)

Solder requirements

Application of solder paste

Before the components are assembled, solder paste must be applied to all the solder pads (for connecting surface-mount components) and the plated through contacts (pcb holes for "Pin in Hole Intrusive Reflow" insertion). Usually a screen printing process is used for this purpose. A squeegee moves across the pcb, which is masked with screens and presses the solder paste into all unmasked areas. To ensure that the plated through holes are completely filled, significantly more solder paste must be applied than traditional solder pads on the pcb surface. The required quantity can be set exactly via several parameters.

As an alternative to screen printing, the solder paste can be applied by means of a dispenser. A high-precision robot moves the dispenser to all required positions on the pcb. The dispensing method is particularly suitable for small pcb's or applications which demand high precision and flexibility in dispensing volumes.

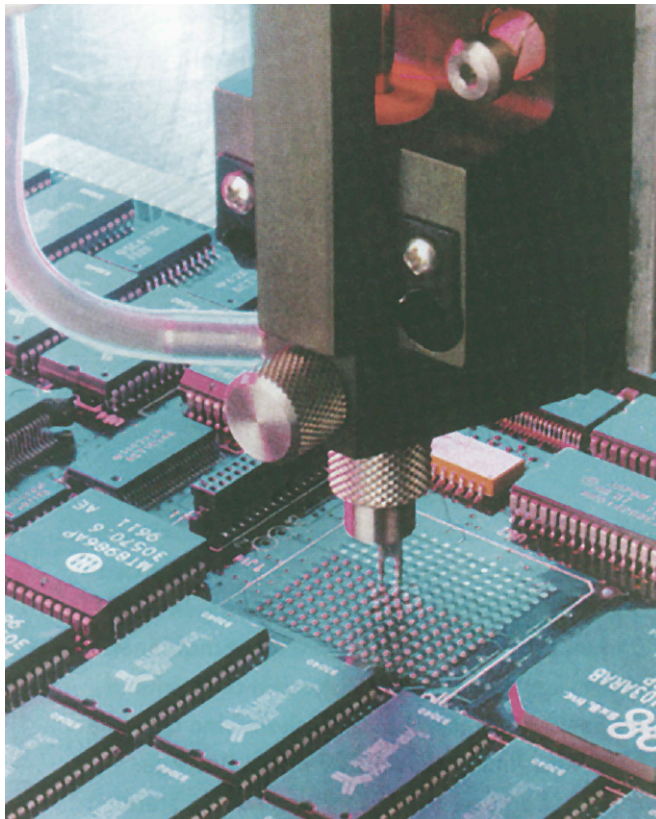

Fig. 3: Dispenser in operation

Requirements for the solder connection

There are numerous scientific studies dealing with calculation of the required quantity of solder paste. These studies use various parameters, e.g. the shrinking factor of the paste during soldering or the thickness of the screens used for masking the pcb. Since such calculation methods are complicated to apply, the following rule of thumb has proved valuable in practice:

$$V_{\text{Paste}} = 2(V_{\text{H}} - V_{\text{P}})$$

in which:

V_{Paste} = Required volume of solder paste

V_{H} = Volume of the plated through hole

V_{P} = Volume of the connector termination in the hole

Comment: the multiplier "2" compensates for solder paste shrinkage during soldering. For this purpose, it was assumed that 50 % of the paste consists of the actual solder, the other 50 % being soldering aids.

At the beginning of a new production batch, the process parameters, such as quantity of solder paste and soldering temperature, can be set by interpreting simple cross-sections of the soldered connection. A reliable measure for achieving optimum parameters is the quantity of solder required to fill the hole. In soldered connections of high quality, the holes are filled to between 75 % and 100 %.

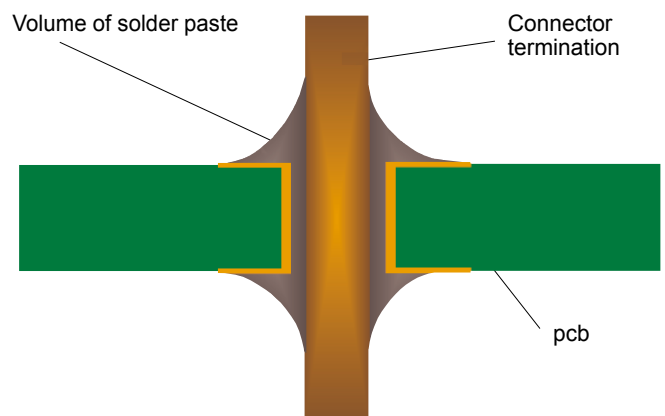

Fig. 4: Plated through hole with connector termination

Requirements for THR connectors

THR (Through Hole Reflow) connectors have to withstand temperatures of up to 240 °C in the reflow oven for 10 to 15 seconds. Therefore, the moulding must be made from a dimensionally stable plastic which expands at the same rate as the pcb material when subjected to heat.

The length of the connector contacts should be such that they protrude by no more than 1.5 millimetres after insertion to the pcb. Each contact collects solder on its tip as it penetrates the solder paste in the hole. So if the contact was too long, this solder would no longer be able to reflow back into the plated through hole by capillary action during the soldering process, therefore the quality of the soldered connection would suffer as a result.

Connector design must permit both automatic assembly with pick-and-place machines and manual positioning for test and pre-production batches. It is also important for the packaging of the connectors to be suitable for automated assembly. Experience shows that deep-drawn film and reel packaging fed into the pick-and-place machines with the aid of a conveyor system is particularly suitable.

HARTING THR technology

HARTING offers its customers a complete system concept for integrating THR technology into existing production lines. We manufacture a wide range of THR connectors (3 and 5 row) in compliance with IEC 60603-2 and D-Sub connectors in compliance with IEC 60807. In addition, HARTING supports the market with packaging and processing concepts, which have been developed in collaboration with renowned manufacturers of THR soldering and assembly plants.

Advantages of the “Pin in Hole Intrusive Reflow” process:

- Partial dip soldering or press fitting is no longer required
- Complete compatibility with Surface Mount Technology
- Complete integration into the automated assembly process
- Reduced floor space in the production plant
- As a rule, no additional investment costs

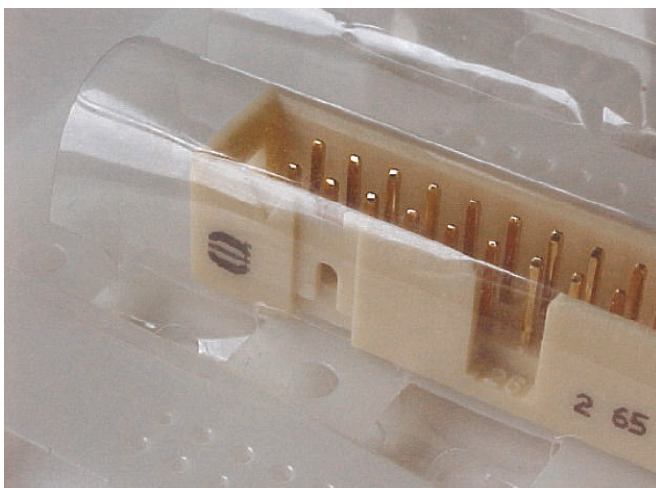

Fig. 5: HARTING connector mounted in a tape ready for placement using an odd form assembly station.

har:press Press-in technology

Solderless termination for connectors has proven to be reliable for decades. Today the use of press-in connectors encompasses all fields of electrical and electronical applications.

Pressing of electrical components, mainly connectors, is characterised through the matching of the connector pin and the plated through hole of the pcb. Whereas the desired electrical characteristics can be attained relatively independent from the design of the press-in zone, the mechanical characteristics of the press-in zone are crucial for the reliable assembly of connectors where pcb's have different surfaces.

Although the scope of requirements at the press-in process is generally defined in time-tested specifications, the novel press-in zones should offer an optimal handling and a reliable termination. Essentially, this is guaranteed through the design of the press-in zone and the meticulous observance of tolerances. HARTING has been using FEM simulations for the calculation and optimisation of press-in zones for a long period of time. This expertise allows us to simulate various pcb configurations very accurate.

Benefits of the press-in technology

- Thermal shocks associated with the soldering process and the risk of the board malfunction are avoided.
- No need for the subsequent cleaning of the assembled pcb's
- Additional wrap connections are made possible by using connectors with long pins
- Unlimited and efficient processing of partially gold-plated pins for rear I/O – manual soldering is no longer necessary!

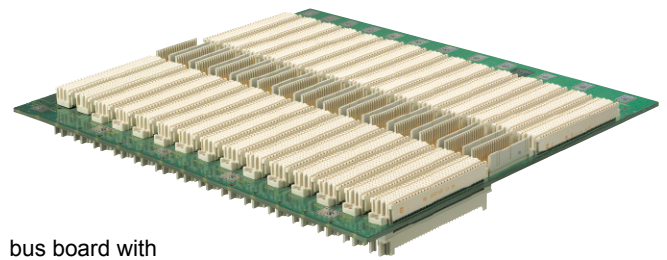

bus board with press-in connectors

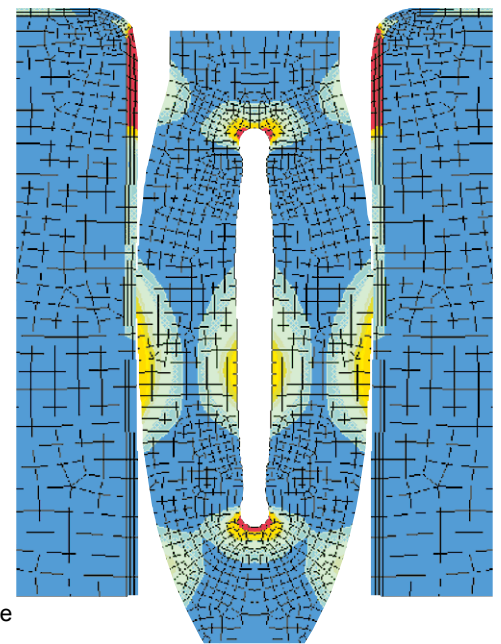

FEM simulation of the needle eye press-in zone

har:press Press-in technology

The processing of press-in connectors can be divided into 3 phases, containing both mechanical and metallurgical operations:

1. Centering and placing of the termination pins

The centering of connectors before pressing is important in order to prevent damage to the pcb and the termination pins. Centering can be omitted when connectors are pressed using a flat rock die.

HARTING offers insert blocks for male connectors to make the centering of connectors unnecessary.

2. Pressing in the pins

In the press-in process the insertion force is continuously transformed into compression force. The resulting friction frees the contacting bars of insulating films. Superfluous plating (tin) is transferred within the plated through hole. A gas-tight connection of fresh non-oxidised metal surfaces is obtained.

3. Obtaining the final position

The press-in operation should be terminated as soon as the connector obtains its final position on the pcb to avoid unnecessary compressive stress. The press-in machines of HARTING feature automatic termination of the press-in operation independent of pcb thickness and surface properties.

The entire dynamic press-in process is characterised through changes of the press-in force that can be statistically evaluated. HARTING records the changes of force with the help of special software. This is an important step towards permanent process control and documented manufacturing data.

The *harpress*-zone is based on the industry renowned needle eye technology. Its special design allows for compensation of tolerances of pcb surface properties (eg. superfluous tin plating). The excessive material is displaced within the plated through hole, whereby a gas-tight and corrosion resistant electrical connection is assured.

Phase 1

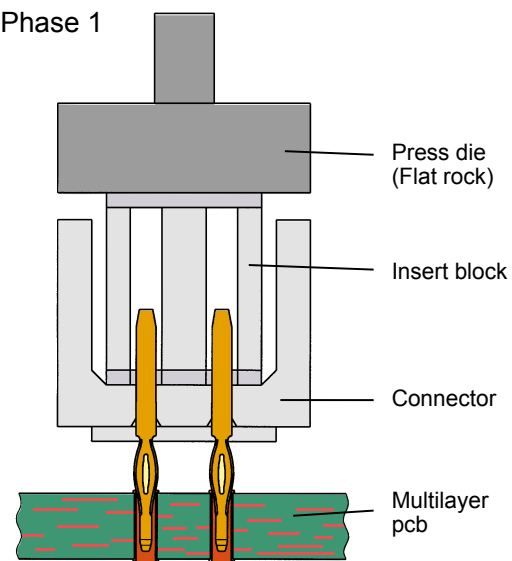

Phase 2

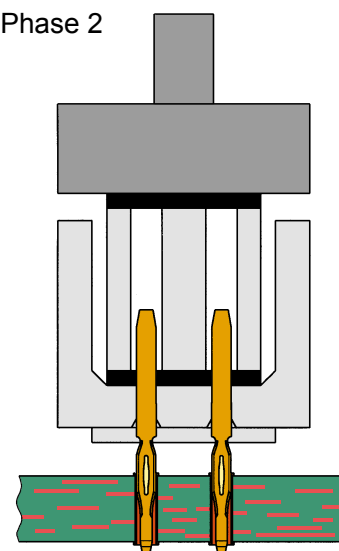

Phase 3

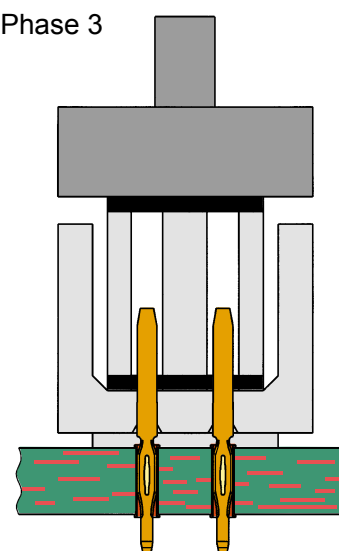

Recommended configuration of plated through holes

Due to the high deformation resistance and resilience of **harpress** contacts, they can be easily and repeatedly removed in case of repairs without impairment to their functioning.

harpress is extremely versatile and offers a reliable electrical contact, therefore it is especially well suited for applications with these surfaces.

Please contact us for detailed test reports.

In addition to the hot-air-level (HAL) other pcb surfaces are getting more important. Due to their different properties, such as mechanical strength and coefficient of friction we recommend the following configuration of pcb through holes.

<i>Tin-lead plated PCB (HAL) acc. EN 60 352-5</i>	Hole-Ø	1.15±0.025 mm
	Cu	min. 25 µm
	Sn	max. 15 µm
	Plated hole-Ø	0.94-1.09 mm

<i>Chemical tin-plated PCB</i>	Hole-Ø	1.15±0.025 mm
	Cu	min. 25 µm
	Sn	min. 0.8 µm
	Plated hole-Ø	1.00-1.10 mm

<i>Au / Ni plated PCB</i>	Hole-Ø	1.15±0.025 mm
	Cu	min. 25 µm
	Ni	3-7 µm
	Au	0.05-0.12 µm
	Plated hole-Ø	1.00-1.10 mm

<i>Silver plated PCB</i>	Hole-Ø	1.15±0.025 mm
	Cu	min. 25 µm
	Ag	0.1-0.3 µm
	Plated hole-Ø	1.00-1.10 mm

<i>OSP copper plated PCB</i>	Hole-Ø	1.15±0.025 mm
	Cu	min. 25 µm
	Plated hole-Ø	1.00-1.10 mm

PCB board thickness: ≥ 1.6 mm

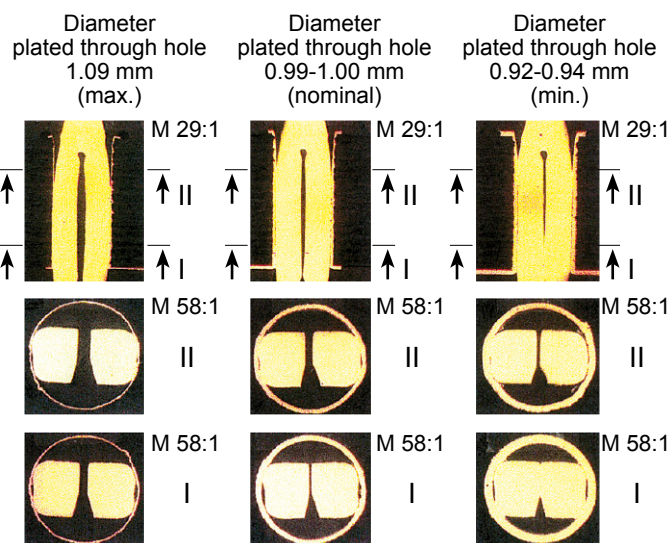

Cross section of a pcb 2.4 mm thick with various hole diameters

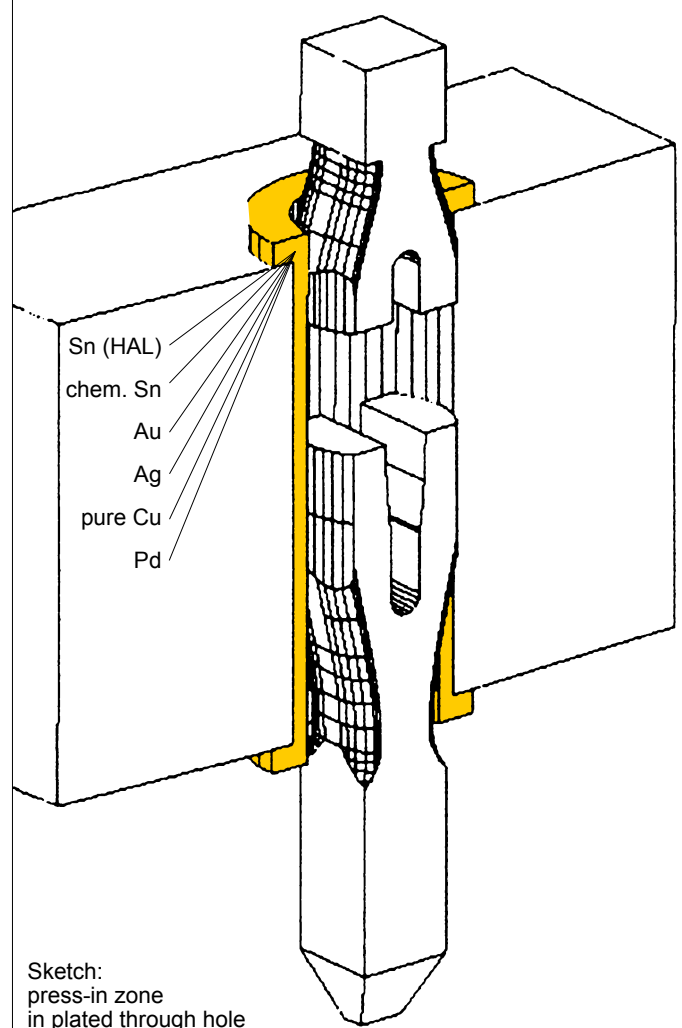

Sketch: press-in zone in plated through hole

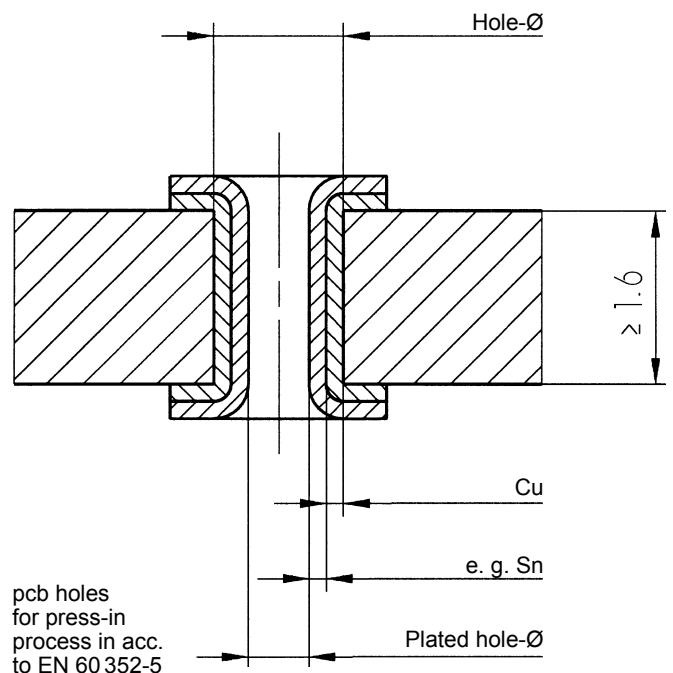

pcb holes for press-in process in acc. to EN 60 352-5

Crimp terminals

A perfect crimp connection is gastight and therefore corrosion free. It is equivalent to a cold weld of the connected parts. For this reason, major features in achieving high quality crimp connections are the design of the crimping areas of the contact and of course the crimping tool itself. Wires to be connected must be carefully matched to the correct size of crimp contacts. If these basic requirements are met, users will be assured of highly reliable connections with a low contact resistance and a high resistance against corrosion.

The economical and technical advantages are:

- Constant contact resistance as a result of an unvariable crimp connection quality
- Corrosion free connections as a result of cold weld action
- Preparation of harnessing with crimp contacts already fitted
- More economic cable connection

Requirements for crimp connections are set out in DIN IEC 60 352-2.

Pull out force of stranded wire

The main criterion by which to judge the quality of a crimp connection is the retention force achieved by the wire conductor in the terminal section of the contact. DIN IEC 60 352, part 2, defines the extraction force in relation to the cross-section of the conductor. When fitted using HARTING crimping tools and subject to their utilization in an approved manner, our crimp connectors comply with the required extraction forces.

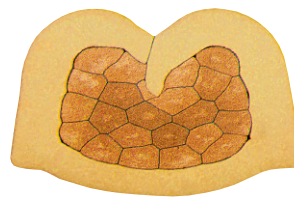

Crimp cross-section

Tensile strength of crimped connections

Conductor cross-section		Tensile strength
mm ²	AWG	N
0.05	30	6
0.08	28	11
0.12	26	15
0.14		18
0.22	24	28
0.25		32
0.32	22	40
0.5	20	60
0.75		85
0.82	18	90
1.0		108
1.3	16	135
1.5		150
2.1	14	200
2.5		230
3.3	12	275
4.0		310
5.3	10	355
6.0		360
8.4	8	370
10.0		380

Extract from DIN IEC 60 352-2, Amend. 2, table IV

Crimping tools

Crimping tools (hand operated or automatic) are carefully designed to guarantee a symmetrical deformation of the crimping area of the contact and the wire through the high pressure forming parts of the tool. The locator automatically engages the crimp contact and the wire at the correct point in the tool. The wire insulation can also be included as a secondary feature of some crimp contacts to care for additional mechanical strength.

The ratchet in the tool performs 2 functions:

- ① It prevents insertion of the crimp into the tool for crimping before the jaws are fully open
- ② It prevents the tool from being opened before the crimping action is completed

A quality crimp connection can be achieved with this crimping system. The adjacent sketches show important features of the HARTING hand crimping tool.

The HARTING automatic crimping tool uses bandoliered contacts. The machine strips insulation from the wire and then crimps the contact. Both the crimping area and the insulation support are independently adjustable to facilitate the use of any wire type with dimensions within the stated crimp capacity.

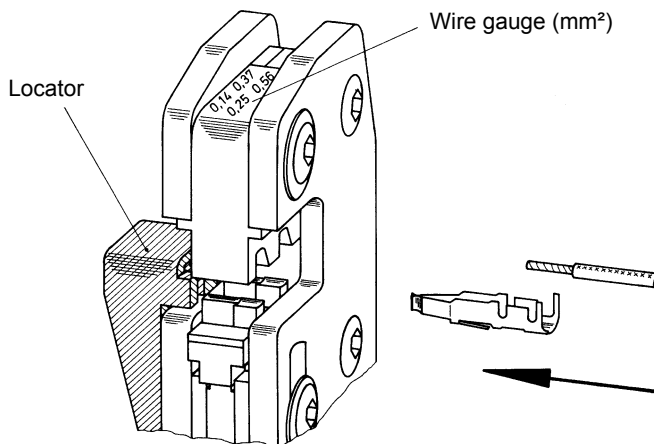

Wire wrap terminals

This technique permits high wiring density and takes over where other techniques would take up too much real estate. As a result of this process, there is a great time saving factor and cost per connection is relatively low when large numbers of connections are to be made.

When wires are correctly wrapped onto a precision manufactured rectangular post produced to the recommended specifications, one can state the following:

A low resistance, mechanically strong and highly reliable connection is made which is unaffected by normal climatic or temperature changes.

Production of wrapped connections and associated material are defined in DIN EN 60352-1.

Wrapping techniques

Standard wrap

Only the non-insulated part of the wire is wrapped around the post. This means that the size of the wrapped connection is kept to the very minimum.

Modified wrap

The top part of the wrapped connection is made using the cable conductor as stated above but an extra turn is made at the bottom. For this turn insulation is also wrapped around the post to give a great mechanical strength to the joint and also to provide insulation between adjacent posts.

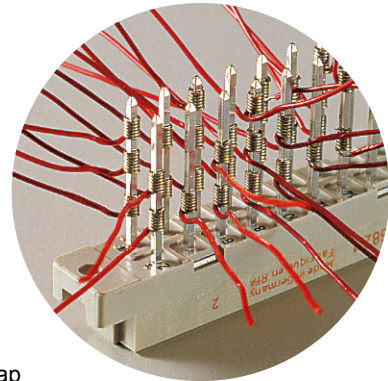

Standard wrap

Wire diameter [mm]						
0.25	0.32	0.4	0.5	0.65	0.8	1.0
max. allowed wire Ø incl. wire insulation [mm]						
0.7	0.9	1.17	1.27	1.32	1.5	1.78

Valid for standard wrap

min. necessary turns per wrap connection (for non-insulated wire)						
7	7	6	5	4	4	4

Dimension of wire wrap post [mm]	Length of wire wrap post [mm]	possible wrap connections per wrap post						
		0.25	0.32	0.4	0.5	0.65	0.8	
0.6 x 0.6	13	6	5	4	4	4	3	2
0.6 x 0.6	17	8	6	6	5	5	4	3
1 x 1	20	10	7	7	6	6	5	4
1 x 1	22	11	8	7	7	6	5	4

Table 00.05

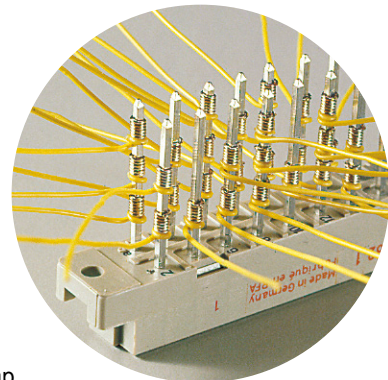

Modified wrap

Wire diameter [mm]						
0.25	0.32	0.4	0.5	0.65	0.8	1.0
max. allowed wire Ø incl. wire insulation [mm]						
0.7	0.9	1.17	1.27	1.32	1.5	1.78

Valid for modified wrap

min. necessary turns per wrap connection (for non-insulated wire)						
7	7	6	5	4	4	4

Dimension of wire wrap post [mm]	Length of wire wrap post [mm]	possible wrap connections per wrap post						
		0.25	0.32	0.4	0.5	0.65	0.8	
0.6 x 0.6	13	4	3	2	2	2	2	1
0.6 x 0.6	17	5	4	3	3	3	2	2
1 x 1	20	6	4	4	3	3	3	2
1 x 1	22	6	5	4	4	4	3	2

Table 00.06

Wrapping tools

To produce quality wrapped connections one must use a special wrapping tool, which can be pneumatic, electric or hand operated. Such tools have interchangeable wrapping heads and sleeves to suit the particular size of the wrap post being used.

The choice of accessories for these wrapping tools depends from the wrapping technique, the size of the wrap post itself and the conductor and insulation diameters of the wire.

The adjacent tables show the maximum amount of wrapped connections that can be placed on the wire wrap post (in acc. to IEC 60352-1).

