

Contents

Page

Summary Han® sizes	Info 00.2
How to order connectors	Info 00.4
Hoods/Housings connector insert protection	Info 00.5
Types of hood/housing	Info 00.6
Locking systems	Info 00.8
Connection technology	Info 00.9
Electrical engineering data	Info 00.19
Current carrying capacity	Info 00.22
Metric cable thread	Info 00.24
Declaration of Conformity	Info 00.25

Info

Info

Size	Description																				
A	<div style="display: flex; justify-content: space-around;"> <div style="text-align: center;"> <p>Hood side-entry</p> </div> <div style="text-align: center;"> <p>Hood top-entry</p> </div> </div>																				
	<table border="0" style="width: 100%; text-align: center;"> <tr> <td>230/400 V 10 A Han® 3 A / 4 A chapter 01</td> <td>50 V 10 A Staf 6 chapter 09</td> <td>250 V 10 A Han® 7 D chapter 02</td> <td>50 V 10 A Han® 8 D chapter 02</td> <td>230/400 V 16 A Han® Q 5/0 chapter 13</td> <td>400 V 10 A Han® Q 7/0 chapter 13</td> <td>50 V 10 A Han-Brid® chapter 19</td> </tr> <tr> <td></td> <td></td> <td></td> <td></td> <td></td> <td></td> <td></td> </tr> <tr> <td>3 / 4 + ⊕</td> <td>6</td> <td>7 + ⊕</td> <td>8</td> <td>5 + ⊕</td> <td>7 + ⊕</td> <td>4 + 2</td> </tr> </table>	230/400 V 10 A Han® 3 A / 4 A chapter 01	50 V 10 A Staf 6 chapter 09	250 V 10 A Han® 7 D chapter 02	50 V 10 A Han® 8 D chapter 02	230/400 V 16 A Han® Q 5/0 chapter 13	400 V 10 A Han® Q 7/0 chapter 13	50 V 10 A Han-Brid® chapter 19								3 / 4 + ⊕	6	7 + ⊕	8	5 + ⊕	7 + ⊕
230/400 V 10 A Han® 3 A / 4 A chapter 01	50 V 10 A Staf 6 chapter 09	250 V 10 A Han® 7 D chapter 02	50 V 10 A Han® 8 D chapter 02	230/400 V 16 A Han® Q 5/0 chapter 13	400 V 10 A Han® Q 7/0 chapter 13	50 V 10 A Han-Brid® chapter 19															
3 / 4 + ⊕	6	7 + ⊕	8	5 + ⊕	7 + ⊕	4 + 2															
3	<table border="0" style="width: 100%; text-align: center;"> <tr> <td></td> <td></td> <td></td> <td></td> <td></td> </tr> <tr> <td>Housing screw mounting</td> <td>Housing bulkhead mounting</td> <td>Housing surface mounting</td> <td>Housing bulkhead mounting</td> <td>Hood cable to cable coupling</td> </tr> </table>						Housing screw mounting	Housing bulkhead mounting	Housing surface mounting	Housing bulkhead mounting	Hood cable to cable coupling										
Housing screw mounting	Housing bulkhead mounting	Housing surface mounting	Housing bulkhead mounting	Hood cable to cable coupling																	
10	<table border="0" style="width: 100%; text-align: center;"> <tr> <td>250 V 16 A Han A® chapter 01</td> <td>250 V 10 A Han D® chapter 02</td> <td>50 V 10 A Staf® chapter 09</td> <td>50 V – 1000 V 5 A – 70 A Han-Modular® chapter 06</td> </tr> <tr> <td></td> <td></td> <td></td> <td></td> </tr> <tr> <td>10 + ⊕</td> <td>15 + ⊕</td> <td>14</td> <td>1 module</td> </tr> </table>	250 V 16 A Han A® chapter 01	250 V 10 A Han D® chapter 02	50 V 10 A Staf® chapter 09	50 V – 1000 V 5 A – 70 A Han-Modular® chapter 06					10 + ⊕	15 + ⊕	14	1 module								
	250 V 16 A Han A® chapter 01	250 V 10 A Han D® chapter 02	50 V 10 A Staf® chapter 09	50 V – 1000 V 5 A – 70 A Han-Modular® chapter 06																	
10 + ⊕	15 + ⊕	14	1 module																		
16	<table border="0" style="width: 100%; text-align: center;"> <tr> <td></td> <td></td> <td></td> <td></td> </tr> <tr> <td>16 + ⊕</td> <td>25 + ⊕</td> <td>20</td> <td></td> </tr> </table>					16 + ⊕	25 + ⊕	20													
16 + ⊕	25 + ⊕	20																			
32	<table border="0" style="width: 100%; text-align: center;"> <tr> <td></td> <td></td> <td></td> </tr> <tr> <td>Housing bulkhead mounting</td> <td>Housing surface mounting</td> <td>Hood cable to cable coupling</td> </tr> </table> <p>suitable for 2 inserts of size 16 A</p>				Housing bulkhead mounting	Housing surface mounting	Hood cable to cable coupling														
Housing bulkhead mounting	Housing surface mounting	Hood cable to cable coupling																			

Info
00
·
2

Size Description

B

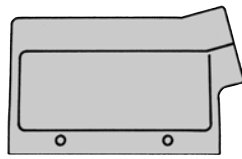

Hood side-entry

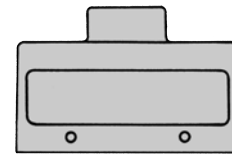

Hood top-entry

250 V 10 A Han D® chapter 02	250 V 10 A Han DD® chapter 02	500 V 16 A Han E® Han® ES chapter 03	500 V 16 A Han® EE Han® EEE chapter 03	400/690 V 35 A Han® HsB chapter 07	830 V 16 A Han Hv E® Han® Hv ES chapter 04	160 V – 690 V 10 A – 100 A Han-Com® chapter 05	50 V – 5000 V 5 A – 200 A Han- Modular® chapter 06
---------------------------------------	--	--	--	---	--	---	--

6

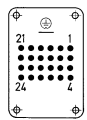

24 + ⚡

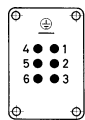

6 + ⚡

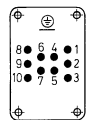

10 + ⚡

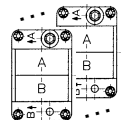

2 modules

10

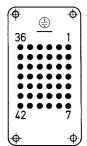

42 + ⚡

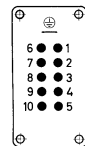

10 + ⚡

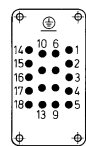

18 + ⚡

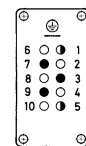

3 + ⚡

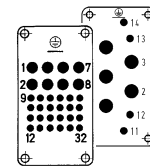

4/4 + ⚡
8/24 + ⚡

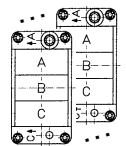

3 modules

16

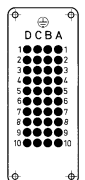

40 + ⚡

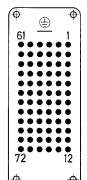

72 + ⚡

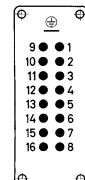

16 + ⚡

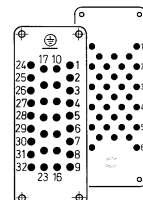

40 + ⚡
32 + ⚡

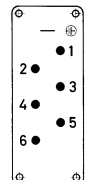

6 + ⚡

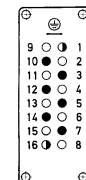

6 + ⚡

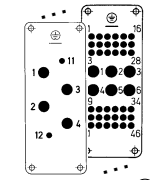

6/36 + ⚡
4/2 + ⚡

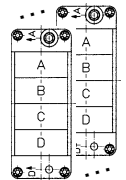

4 modules

24

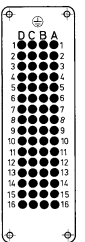

64 + ⚡

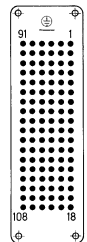

108 + ⚡

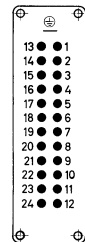

24 + ⚡

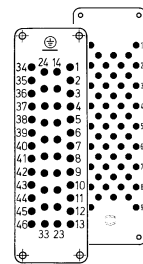

64 + ⚡
46 + ⚡

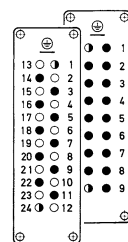

16 + ⚡
10 + ⚡

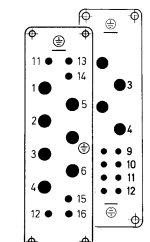

4/8 + ⚡
6/6 + ⚡

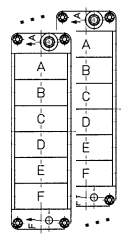

6 modules

Housing surface mounting

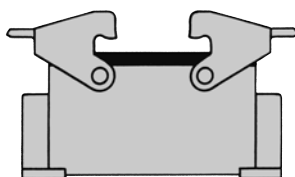

Housing bulkhead mounting

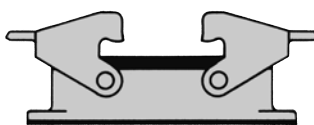

Hood cable to cable coupling

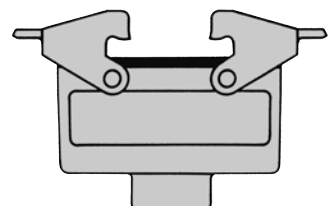

32

suitable for 2 inserts of size 16 B

48

suitable for 2 inserts of size 24 B

Info

For a complete connector components may be ordered from the following sub headings

Cable entry protection

- Universal cable glands
- Special cable clamp with strain relief, bell mouthed cable fitting and anti-twist devices
- Cable gland with normal or multiple seal
- Extensive range of accessories

Hoods

- low or high construction
- top or side cable entry
- 1 or 2 locking levers

Male insert with

- screw terminal or crimp terminal (order contacts separately) or cage-clamp terminal

Female insert with

- screw terminal or crimp terminal (order contacts separately) or cage-clamp terminal

Housings

- Housing (bulkhead mounting) with or without thermoplastic or metal covers
- 1 or 2 locking levers
- Housing (surface mounting) low or high construction with or without thermoplastic or metal covers
- 1 or 2 locking levers
- 1 or 2 cable entries
- Hood (cable to cable) low or high construction for cable to cable connections

Accessories

- Protective covers available
- Code and guide pins for coding
- Special insert fixing screws for use without hoods and housings
- Label according to CSA-approval

Suitable hoods and housings will be found on the same page.

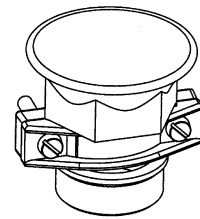

Cable clamp

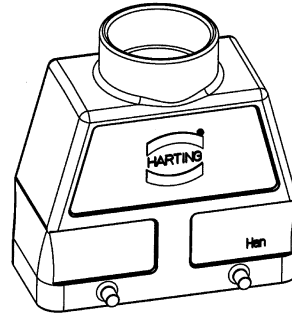

Hood



Male contacts

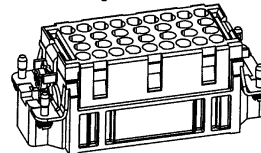

Male insert

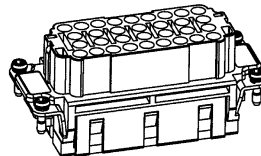

Female insert



Female contacts

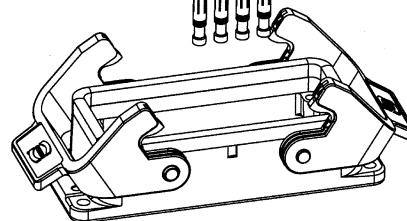

Housing

Part number explanation

Our computerized ordering system uses the following code:

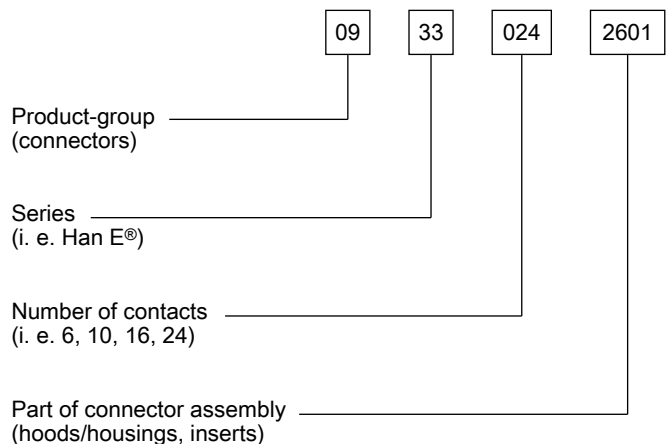

Info

Info
00
·
4

Hoods/Housings connector insert protection



The connector's housing, sealing and locking mechanism protect the connection from external influences such as mechanical shocks, foreign bodies, humidity, dust, water or other fluids such as cleansing and cooling agents, oils, etc. The degree of protection the housing offers is explained in the IEC 60529, DIN EN 60529, standards that categorize enclosures according to foreign body and water protection.

The following table shows the different degrees of protection.

Code letters
(International Protection)











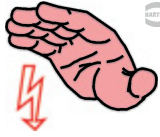

IP

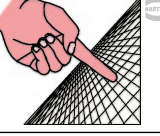
First Index Figure
(Foreign bodies protection)

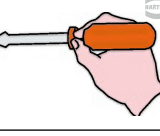
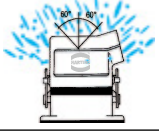
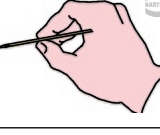
6

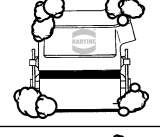
Second Index Figure
(Water protection)

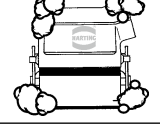
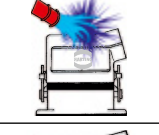
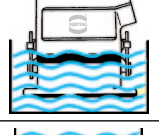
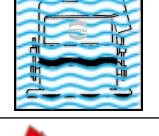
5

Index figure	Degree of protection			Index figure	Degree of protection		
0	No protection		No protection against accidental contact, no protection against solid foreign bodies	0	No protection against water		No protection against water
1	Protection against large foreign bodies		Protection against contact with any large area by hand and against large solid foreign bodies with $\varnothing > 50$ mm	1	Drip-proof		Protection against vertical water drips
2	Protection against medium sized foreign bodies		Protection against contact with the fingers, protection against solid foreign bodies with $\varnothing > 12$ mm	2	Drip-proof		Protection against water drips (up to a 15° angle)
3	Protection against small solid foreign bodies		Protection against tools, wires or similar objects with $\varnothing > 2.5$ mm, protection against small foreign solid bodies with $\varnothing > 2.5$ mm	3	Spray-proof		Protection against diagonal water drips (up to a 60° angle)
4	Protection against grain-shaped foreign bodies		As 3 however $\varnothing > 1$ mm	4	Splash-proof		Protection against splashed water from all directions
5	Protection against injurious deposits of dust		Full protection against contact. Protection against interior injurious dust deposits	5	Hose-proof		Protection against water (out of a nozzle) from all directions
6	Protection against ingress of dust		Total protection against contact. Protection against penetration of dust	6	Strong hose-proof		Protection against strong water (out of a nozzle) from all directions
				7	Protected against immersion		Protected against temporary immersion
				8	Water-tight		Protected against water pressure
				9K*	Protected against high-pressure		Protected against water from high-pressure / steam jet cleaners

Description according to IEC 60529
* ... IPX9K acc. to ISO 20653

Info

Standard hoods/housings for industrial connectors

Field of application	For excellent mechanical and electrical protection in demanding environments, for example, in the automobile and mechanical engineering industries also for process and regulation control applications
Distinguishing feature	Hoods/housings colour-coded grey (RAL 7037)
Material of hoods/housings	Die-cast light alloy
Locking levers	Han-Easy Lock®
Cable entry protection	Optional special cable clamp for hoods with strain relief, bell mouthed cable fitting and anti-twist devices



Han® M hoods/housings for more demanding environmental requirements

Field of application	For all applications where aggressive environmental conditions and extreme climatic atmospheres are encountered
Distinguishing feature	Hoods/housings colour-coded black (RAL 9005)
Material of hoods/housings	Die-cast light alloy, corrosion resistant
Locking levers	Corrosion resistant stainless steel
Cable entry protection	Special cable clamp for hoods with strain relief, bell mouthed cable fitting and anti-twist devices

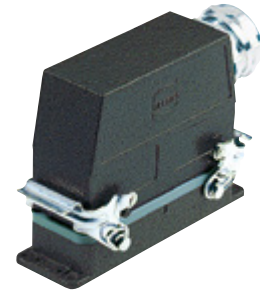

Han® EMC hoods/housings for higher EMC requirements

Field of application	For sensitive interconnections that have to be shielded against electrical, magnetic or electro-magnetic interferences
Distinguishing feature	Electrically conductive surface, internal seal
Material of hoods/housings	Die-cast light alloy
Locking levers	Han-Easy Lock®
Cable entry protection	EMC cable clamp in order to connect the cable shielding to the hood without interruption of the shielding



Han® HPR hoods/housings for harsh outdoor environments

Field of application	For external electrical interconnections in vehicles, in highly demanding environments and wet areas, as well as for sensitive interconnections that have to be shielded
Distinguishing feature	Hoods/housings colour-coded black, internal seal (RAL 9005)
Locking parts	Stainless steel
Material of hoods/housings	Die-cast light alloy, corrosion resistant
Cable entry protection	Optional universal cable clamp for hoods with strain relief, or special cable clamp with bell mouthed cable fitting and anti-twist devices (use of adapter is necessary)



Han-INOX® hoods/housings for harsh environments

Field of application	For excellent mechanical and electrical protection in demanding environments, for example, in the food, automobile and mechanical engineering industries also for process and regulation control applications
Distinguishing feature	Matt-finished metal surface
Material of hoods/housings	Stainless steel
Locking levers	Stainless steel
Cable entry protection	Standard cable gland (stainless steel)



Han-Eco® – Lightweight hood/housing made of high-performance plastic

Field of application	Industrial environments, outdoor applications
Distinguishing feature	Black plastic hoods / housings
Material of hoods/housings	Polyamide (glass-fibre reinforced)
Locking levers	Double locking lever / single locking lever (10 A / 16 A) (polyamide, glass-fibre reinforced)
Cable entry protection	Integrated plastic cable gland (optional) for sizes 6 B, 10 B, 16 B, 24 B / 10 A, 16 A



Han-Yellok® – Compact hood/housing in a shapely design

Field of application	Industrial environments (e.g. in robotics, machinery)
Distinguishing feature	Internal locking mechanism, push-buttons, two-part hood
Material of hoods/housings	Zinc die-cast, aluminum
Locking parts	Stainless steel and polyamide
Cable entry protection	Standard cable gland (with metric threads M20 / M25 / M32 / M40) for hoods with strain relief or special cable glands



Recommended tightening torque for housings, bulkhead mounting

Series	Number of screws	Size of screws	Recommended Tightening torque (Nm)	Remarks
Han® 3 A	2	M 3	0.8 ... 1.0	Gasket
Han® 10 A / 16 A	4	M 3	0.8 ... 1.0	Gasket
Han® 10 EMV / 16 EMV	4	M 3	min. 1.0	O-ring
Han® 32 A	4	M 4	0.8 ... 1.0	Gasket
Han® 6 B / 10 B / 16 B / 24 B	4	M 4	0.8 ... 1.0	Gasket
Han® 32 B	4	M 5	min. 2.5	O-ring
Han® 48 B	4	M 6	min. 3.0	O-ring
Han® 3 HPR	2	M 4	min. 1.0	O-ring
Han® 6 / 10 / 16 / 24 HPR	4	M 6	min. 3.0	O-ring
Han® 48 HPR	4	M 8	min. 5.0	O-ring

To offer safe protection the surface condition for mounting panel should be according to DIN 4766:

- Waviness ≤ 0.2 mm on 200 mm distance
- Roughness $R_a \leq 16$ μm

General remark for assembling

During assembly and handling of the connector, any kind of damage to the surface of the housing must be avoided to guarantee the correct surface protection.

Info

Housing with 2 levers Han-Easy Lock®

- easy operation
- high degree of pressure tightness
- reliable locking guaranteed by 4 locking points
- space saving mounting
- ideal for mounting side by side
- cable to cable connection is possible
- high seal force

Details of Han-Easy Lock® see chapter 31



Housing with 1 lever Han-Easy Lock®

- easily accessible, even with side entry
- possibility to lock protective covers on the housing
- cable to cable connection is possible
- 2 locking points on the longitudinal axis



1 lever in central position

- easily accessible, even with side entry
- 2 locking points on the lateral axis
- space saving mounting
- ideal for mounting side by side
- single hand operation



Screw locking / toggle locking

- hexagon nuts tightened with spanner
- highest degree of pressure tightness
- easily accessible, also with side entry
- use of tools avoids access by unauthorized persons



Hood with 2 levers Han-Easy Lock®

- easy operation
- high degree of pressure tightness
- ideal for mating to housings with protection cover
- high seal force

Details of Han-Easy Lock® see chapter 31



Info
00
·
8

Crimp connection

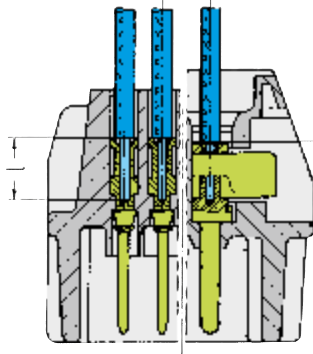

Han DD®
 Han D®
 R 15
 Han-Modular® (10 A)
 Han E®
 Han A®
 Han Hv E®

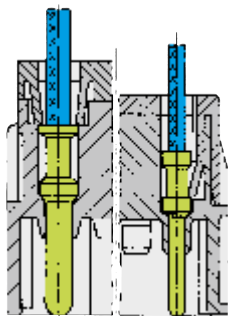

Han-Com® (40 A)
 Han-Modular® (40 A)
 Han E®
 Han A®
 Han Hv E®
 Han® EE
 Han® EEE
 Han-Modular® (16 A)
 Han® Q

A perfect crimp connection is gastight, therefore corrosion free and amounts to a cold weld of the parts being connected. For this reason, major features in achieving high quality crimp connections are the design of the contact crimping parts and of course the crimping tool itself. Wires to be connected must be carefully matched with the correct size of crimp contacts. If these basic requirements are met, users will be assured of highly reliable connections with low contact resistance and high resistance to corrosive attack.

The economic and technical advantages are:

- Constant contact resistance as a result of precisely repeated crimp connection quality
- Corrosion free connections as a result of cold weld action
- Pre-preparation of cable forms with crimp contacts fitted
- Optimum cost cable connection

Requirements for crimp connectors are laid down in DIN EN 60352-2 as illustrated in the table.

Pull out force of stranded wire

The main criterion by which to judge the quality of a crimp connection is the retention force achieved by the wire conductor in the terminal section of the contact. DIN EN 60352-2 defines the extraction force in relation to the cross-section of the conductor. When fitted using HARTING crimping tools and subject to their utilization in an approved manner, our crimp connectors comply with the required extraction forces.

Crimping tools

Crimping tools (hand operated or automatic) are carefully designed to produce with high pressure forming parts a symmetrical connection of the crimping part of the contact and the wire being connected with the minimum increase in size at the connection point. The positioner automatically locates the crimp and wire at the correct point in the tool.

A ratchet in the tool performs 2 functions:

- It prevents insertion of the crimp into the tool for crimping before the jaws are fully open
- It prevents the tool being opened before the crimping action is completed

Identical, perfectly formed, connections can be produced using this crimping system.

Crimp-cross section



HARTING-crimp profile



BUCHANAN crimp profile

Tensile strength of crimped connections
 (Table 1 of the DIN EN 60352-2)

Conductor cross-section		Tensile strength
mm ²	AWG	N
0.05	30	6
0.08	28	11
0.12	26	15
0.14		18
0.22	24	28
0.25		32
0.32	22	40
0.5	20	60
0.75		85
0.82	18	90
1.0		108
1.3	16	135
1.5		150
2.1	14	200
2.5		230
3.3	12	275
4.0		310
5.3	10	355
6.0		360
8.4	8	370
10.0		380

Wire gauge		Internal diameter Ø (mm)	Stripping length l (mm)		
(mm ²)	AWG		Han® DD Han® D R15 Han-Modular® (10 A)	Han E® Han A® Han Hv E®	Han® C
0.14 ... 0.37	26 ... 22	0.9	8	-	-
0.5	20	1.15	8	7.5	-
0.75	18	1.3	8	7.5	-
1	18	1.45	8	7.5	-
1.5	16	1.75	8	7.5	9.5
2.5	14	2.25	6	7.5	9.5
4	12	2.85	-	7.5	9.5
6	10	3.5	-	-	9.5
10	8	4.3	-	-	12-18

Crimp connection

Info

	Conductor cross-section	ø	Stripping length
TC 70	10 mm ²	4.3 mm	15.5 mm
	16 mm ²	5.5 mm	15.5 mm
	25 mm ²	7.0 mm	15.5 mm
TC 100	10 mm ²	4.3 mm	19.0 mm
	16 mm ²	5.5 mm	19.0 mm
	25 mm ²	7.0 mm	19.0 mm
	35 mm ²	8.2 mm	19.0 mm
TC 200	25 mm ²	7.0 mm	19.0 mm
	35 mm ²	8.2 mm	20.0 mm
	50 mm ²	10.0 mm	22.5 mm
	70 mm ²	11.5 mm	22.5 mm
Han® 100 A Modul	10 mm ²	4.3 mm	19.0 mm
	16 mm ²	5.5 mm	19.0 mm
	25 mm ²	7.0 mm	19.0 mm
	35 mm ²	8.2 mm	16.0 mm
Han® HC Modular 250	35 mm ²	8.45 mm	22.0 mm
	50 mm ²	10.25 mm	22.0 mm
	70 mm ²	11.75 mm	22.0 mm
Han® HC Modular 350	25 mm ²	7.0 mm	26.0 mm
	35 mm ²	8.2 mm	26.0 mm
	50 mm ²	10.0 mm	28.0 mm
	70 mm ²	11.5 mm	28.0 mm
	95 mm ²	13.5 mm	30.0 mm
	120 mm ²	15.5 mm	24.0 mm
Han® HC Modular 650	240 mm ²	22.5 mm	50.0 mm
for fine stranded wires according to IEC 60 228 class 5			

Screw terminal

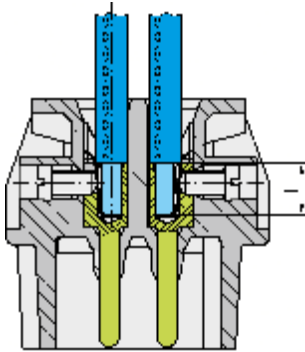

Screw terminals meet VDE 0609 /EN 60 999. Dimensions and tightening torques for testing are shown in following table.

Screw dimensions and tightening torque for screw terminals

Wire gauge (mm ²)	1.5	2.5	4	6	10	16
Screw thread	M3	M3	M3.5	M4	M4	M6
Test moment of torque (Nm)	0.5	0.5	0.8	1.2	1.2	1.2*
min. pull-out for stranded wire (N)	40	50	60	80	90	100

* for screws without heads

The relevant regulations state that in the case of

- Terminals with wire protection

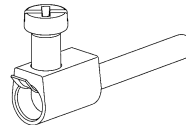

the use of ferrules is not necessary. Series Han E[®], Han[®] HsB, Han Hv E[®], Han[®] K 6/12, Han[®] K 6/6

- Terminals without wire protection

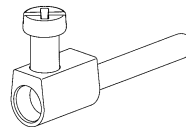

The insulation is first stripped and then a wire ferrule must be used.

Series Han[®] K 4/x, Han A[®], Staf[®]

Screw terminal

Inserts	Wire protection		min. wire gauge		max. wire gauge*		Stripping length mm
	Yes	No	mm ²	AWG	mm ²	AWG	
Han [®] 3 A, Han [®] 4 A		X	0.75	18	1.5	16	4.5
Han [®] 10 A, 16 A, 32 A		X	0.75	18	2.5	14	7.5
Han E [®] , Hv E [®]	X		0.75	18	2.5	14	7.5
Han [®] HsB	X		1.5	16	6	10	11.5
Han [®] K 6/6, K 6/12 (signal contacts)	X		0.2	24	2.5	14	7.5
Han [®] K 4/2, K 4/8 (signal contacts)		X	0.5	20	2.5	14	7.5
Han [®] K 4/0, K 4/2, K 4/8 (power contacts)		X	1.5	16	16	6	14
Han E [®] AV, Han D [®] AV	X		0.2	24	2.5	14	8 ... 11
Staf [®]		X	0.5	18	1.5	16	4.5

* Rated wire gauge according to DIN EN 60 999-1

Recommended screw drivers and tightening torques

Screw size	Connector type	Tightening torque (Nm)	Tightening torque (lbft)	Recommended screw driver
M2.5	Cover / cable clamp screws: Han® Megabit, Han® Gigabit, Han® Shielded Module	0.40	0.30	PH 1
M3	Screw terminals: Han® 3 A, Han® 4 A, Han® Q 5/0 (PE), Han® Q 7/0 (PE), Staf®	0.25	0.20	slotted 0.4 x 2.5
M3	Screw terminals: Han D® AV, Han E® AV, Han® K 6/6, Han® K 6/12 (signal)	0.50	0.40	slotted 0.5 x 3.0
M3	Screw terminals: Han® 10A ... 32A, Han® E, Han Hv E®, Han® HsB	0.50	0.40	slotted 0.6 x 3.5 or PH 1
M3	Screw terminals: Han® E High Temp, Han® Thermocouple	0.50	0.40	slotted 0.6 x 3.5
M3	Cable clamp screws: Han-Quintax®, Han-Quintax® High Density, Han® D Coax, Han® E Coax	0.70	0.50	slotted 0.6 x 3.5
M3	Cable clamp screws: Han® D-Sub, USB Module	0.50	0.40	slotted 0.6 x 3.5 or PH 1
M3	Fixing screws: Connectors sizes 10 A, 16 A	0.50	0.40	slotted 0.6 x 3.5 or PH 1
M3	Fixing screws: Connectors sizes 6 B ... 24 B	0.50	0.40	slotted 0.6 x 3.5 or PH 2
M3	Ground terminals: Han-Modular® Hinged frames 1 ... 2.5 mm ²	0.80	0.60	slotted 0.6 x 3.5 or PH 2
M3	Han® guiding pins and bushes	0.50	0.40	slotted 1 x 6.0
M3.5	Ground terminals: Han® 10 A, Han® 16 A, Han 15 D®, Han 25 D®	0.80	0.60	slotted 0.6 x 3.5 or PH 1
M4	Screw terminals: Han® HsB	1.20	0.90	slotted 0.6 x 3.5 or PH 1
M4	Fixing screws: Han-Yellock®	1.20	0.90	slotted 0.8 x 4.5 or PH 2
M4	Ground terminals: Han-Modular® Hinged frames 4 ... 10 mm ²	1.20	0.90	slotted 0.6 x 3.5 or PH 2
M4	Ground terminals: Han E®, Han® ES, Han® ESS, Han® ES Press, Han Hv E®, Han® Hv ES, Han E® High Temp, Han 40 D®, Han 64 D®, Han DD®, Han® K 8/24, Han® K 4/X, Han® K 6/12, Han® K 6/36	1.20	0.90	slotted 0.8 x 4.5 or PH 2
M5	Ground terminals: Han® HsB, Han® K12/2, Han® K4/X, Han® K6/12, Han® K6/36	2.00	1.40	slotted 0.8 x 4.5 or PH 2
M6	Screw terminals: Han® K power contacts, Han-Eco® PE module	for Han® K see chapter 05, Han-Eco® PE module (1.2-3 Nm)		slotted 0.8 x 4.5

Increasing the tightening torque does not improve considerably the contact resistances. The torque moments were determined when optimum mechanical, thermal and electrical circumstances were given. If the recommended figures are considerably exceeded the wire or the termination can be damaged.

Han-Quick Lock® termination technique

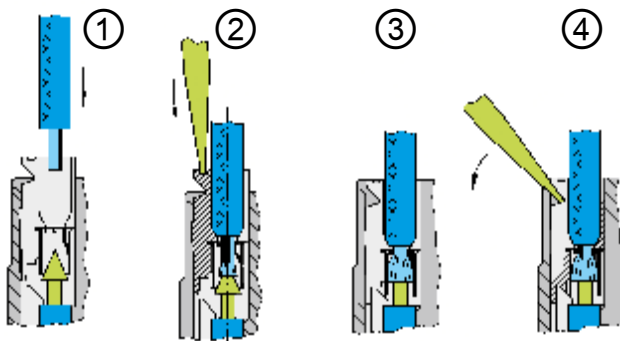
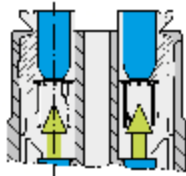

This new termination technique from HARTING combines the reliability and the simple operation of the cage clamp termination with the low space requirements of crimp technology.

Han-Quick Lock® is ideally suited to high contact densities and is considerably superior over other termination techniques. No other technology is so simple, space saving and fast. For this vibration safe termination, no special tools are necessary.

- Fast, simple and robust termination technique
- Field assembly without a special tool
- Compatible also to inserts with other termination technologies
- Combines high contact density similar to crimp termination with the simple connection like a cage clamp terminal
- For stranded wire according to IEC 60228 Class 5

Insert connectors:

Han® 3 A
 Han® 4 A
 Han® 7 D
 Han® 8 D
 Han® Q 4/2
 Han® Q 5/0
 Han® Q 8/0
 Han® Q 12/0
 Han® EE modules
 Han® DD modules
 Han® PushPull Power 4/0

Technical characteristics:

Material

Isolation body	Polycarbonate
Active termination element	Polycarbonate
Quick-Lock spring	Stainless steel
Contact	Copper alloy

Blue slide

Terminal cross-section
 0.5 ... 2.5 mm² / AWG 20 ... 14

Black slide

Terminal cross-section
 0.25 ... 1.5 mm² / AWG 23 ... 16

Stripping length

10 mm

Insulating resistance

> 10¹⁰ Ohm

Flammability

according to UL 94 V 0

Termination tool

Screwdriver
 0.4 x 2.5 mm resp.
 0.5 x 3.0 mm (recommended for wire gauges > 1.5 mm²)

Axial screw terminal

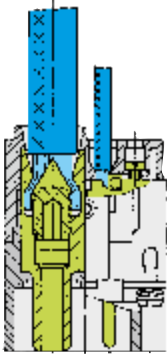

This termination combines the benefits of screw and crimp terminations:

- Less space required
- Easy handling
- No special tools

Remarks on the axial screw technique

The wire gauges mentioned in the catalogue refer to geometric wire gauges of cables.

Background:

According to DIN EN 60 228 for cables and insulated wires the wire gauge will be determined by conductance (Ω/km) and maximum wire diameter. A minimum cable diameter is not specified! (Example: nominal wire gauge = 95 mm^2 → real, geometric wire gauge = 89 mm^2)

Recommendation:

If you want to apply the axial screw technique in combination with cables that have cross sections extremely deviating from the nominal value, this must be checked separately.

Strain relief:

In order to ensure that the contact is protected against radial stress, you must fix the cable at an adequate distance from the terminal.

Details for professional strain relief design can be found in the standard DIN VDE 0100-520: 2003-06 (see enclosed table).

Outer cable diameter (mm)	Maximum fixing distance (mm)	
	horizontal	vertical
$D \leq 9$	250	400
$9 < D < 15$	300	400
$15 < D < 20$	350	450
$20 < D < 40$	400	550

Cables:

The axial screw technology is developed for wires according to DIN EN 60 228 class 5 (see table: Wire assembly according to DIN EN 60 228). Deviating cable assemblies have to be tested separately.

Assembly remarks:

Before starting the assembly the user must ensure that the axial cone is screwed fully downward to completely open the contact chamber.

After stripping the cable insulation the strands must not be twisted and the maximum cable insulation must not exceed the recommended dimension.

Insert the wire completely into the contact chamber until the copper strands reach the bottom. Keep the cable in position while applying the recommended tightening torque.

Maintenance of the axial screw termination:

In order to avoid damage to individual cable strands you must re-apply the tightening torque only once after the initial assembly of the application.

Wire gauge (mm ²)	Stranded wires DIN EN 60228 class 2	Fine stranded wires DIN EN 60228 class 5	Super fine stranded wires DIN EN 60228 class 6			
			28 x 0.15	64 x 0.10	131 x 0.07	256 x 0.05
0.5	7 x 0.30	16 x 0.20	28 x 0.15	64 x 0.10	131 x 0.07	256 x 0.05
0.75	7 x 0.37	24 x 0.20	42 x 0.15	96 x 0.10	195 x 0.07	384 x 0.05
1	7 x 0.43	32 x 0.20	56 x 0.15	128 x 0.10	260 x 0.07	512 x 0.05
1.5	7 x 0.52	30 x 0.25	84 x 0.15	192 x 0.10	392 x 0.07	768 x 0.05
2.5	7 x 0.67	50 x 0.25	140 x 0.15	320 x 0.10	651 x 0.07	1280 x 0.05
4	7 x 0.85	56 x 0.30	224 x 0.15	512 x 0.10	1040 x 0.07	
6	7 x 1.05	84 x 0.30	192 x 0.20	768 x 0.10	1560 x 0.07	
10	7 x 1.35	80 x 0.40	320 x 0.20	1280 x 0.10	2600 x 0.07	
16	7 x 1.70	128 x 0.40	512 x 0.20	2048 x 0.10		
25	7 x 2.13	200 x 0.40	800 x 0.20	3200 x 0.10		
35	7 x 2.52	280 x 0.40	1120 x 0.20			
50	19 x 1.83	400 x 0.40	705 x 0.30			
70	19 x 2.17	356 x 0.50	990 x 0.30			
95	19 x 2.52	485 x 0.50	1340 x 0.30			
120	37 x 2.03	614 x 0.50	1690 x 0.30			
150	37 x 2.27	765 x 0.50	2123 x 0.30			
185	37 x 2.52	944 x 0.50	1470 x 0.40			
240	61 x 2.24	1225 x 0.50	1905 x 0.40			

Wire assembly according to DIN EN 60 228

Insert	Wire gauge	Stripping length		Tightening torque		Max. cable insulation diameter	Size hexagon recess	Insert dimension for cable indication (ISK)
	(mm ²)	(mm)		(Nm)		(mm)	(SW)	(mm)
Han® K 4/4 finger safe	6 ... 16	6 mm ² :	11+1	6 mm ² :	2	8.9	2.5	7.4 PE: 8.9
		10 mm ² :	11+1	10 mm ² :	3			
16 mm ² :		11+1	16 mm ² :	4				
	10 ... 22	10 mm ² :	11+1	10 mm ² :	3	8.9 8.9 11	2.5	7.4 7.4 5.4 PE: 8.9
		16 mm ² :	11+1	16 mm ² :	4			
		22 mm ² :	11+1	22 mm ² :	4			
Han® K 4/4	6 ... 16	6 mm ² :	11+1	6 mm ² :	2	8.9	2.5	7.4 PE: 8.9
		10 mm ² :	11+1	10 mm ² :	3			
16 mm ² :		11+1	16 mm ² :	4				
	10 ... 22	10 mm ² :	11+1	10 mm ² :	3	8.9 8.9 11	2.5	7.4 7.4 5.4 PE: 8.9
		16 mm ² :	11+1	16 mm ² :	4			
		22 mm ² :	13+1	22 mm ² :	4			
Han® K 6/12	2.5 ... 8	2.5 mm ² :	5+1	2.5 mm ² :	1.5	6.2	2	7.4
		4 mm ² :	5+1	4 mm ² :	1.5			
6 mm ² :		8+1	6 mm ² :	2				
8 mm ² :		8+1	8 mm ² :	2				
	6 ... 10	6 mm ² :	8+1	6 mm ² :	2	6.2	2	4.7
		8 mm ² :	8+1	8 mm ² :	2			
		10 mm ² :	8+1	10 mm ² :	2			
Han® K 6/6	10 ... 25	10 mm ² :	13+/-1	10 mm ² :	6	11.4	4	4.9
		16 mm ² :	13+/-1	16 mm ² :	6			
25 mm ² :		13+/-1	25 mm ² :	7				
	16 ... 35	16 mm ² :	13+/-1	16 mm ² :	6	11.4	4	4.9
		25 mm ² :	13+/-1	25 mm ² :	7			
		35 mm ² :	13+/-1	35 mm ² :	8			
Han® K 8/0	10 ... 25	10 mm ² :	13+/-1	10 mm ² :	6	11.4	4	4.75
		16 mm ² :	13+/-1	16 mm ² :	6			
25 mm ² :		13+/-1	25 mm ² :	7				
Han® Q 2/0 Han® Q 2/0 High Voltage	2.5 ... 10	2.5 mm ² :	8+1	2.5 mm ² :	1.8	7.3	2	5.6
		4 mm ² :	8+1	4 mm ² :	1.8			
		6 mm ² :	8+1	6 mm ² :	1.8			
		10 mm ² :	8+1	10 mm ² :	1.8			
Han® Q 4/2 Han® Q 4/2 with Han-Quick Lock®	4 ... 10	4 mm ² :	8+1	4 mm ² :	1.8	7.3	2	5.6
		6 mm ² :	8+1	6 mm ² :	1.8			
		10 mm ² :	8+1	10 mm ² :	1.8			
Han® 200 A module without PE Han® 200 A module with PE	25 ... 40	25 mm ² :	16	25 mm ² :	8	12 16	5	0
		40 mm ² :	16	40 mm ² :	8			
70 mm ² :		16	70 mm ² :	10				
	40 ... 70	40 mm ² :	16	40 mm ² :	9	12 16	5	0
		70 mm ² :	16	70 mm ² :	10			
Han® 100 A module	6 ... 10	6 mm ² :	13+/-1	6 mm ² :	4	11.4	2.5	4.9
		8 mm ² :	13+/-1	8 mm ² :	4			
10 mm ² :		13+/-1	10 mm ² :	4				
	10 ... 25	10 mm ² :	13+/-1	10 mm ² :	6	11.4	4	4.9
		16 mm ² :	13+/-1	16 mm ² :	6			
		25 mm ² :	13+/-1	25 mm ² :	7			
	16 ... 35	16 mm ² :	13+/-1	16 mm ² :	6	11.4	4	4.9
		25 mm ² :	13+/-1	25 mm ² :	7			
		35 mm ² :	13+/-1	35 mm ² :	8			
	38	38 mm ² :	13+/-1	38 mm ² :	8	11.4	4	4.9
Han® 70 A module	6 ... 16	6 mm ² :	11+1	6 mm ² :	2	8.9	2.5	7.4
		10 mm ² :	11+1	10 mm ² :	3			
16 mm ² :		11+1	16 mm ² :	4				
	14 ... 22	14 mm ² :	12.5+1	14 mm ² :	4	10	2.5	5.9
		16 mm ² :	12.5+1	16 mm ² :	4			
		22 mm ² :	12.5+1	22 mm ² :	4			
Han® 40 A module	2.5 ... 8	2.5 mm ² :	5+1	2.5 mm ² :	1.5	4 4 6 10.5	2	4.7
		4 mm ² :	5+1	4 mm ² :	1.5			
6 mm ² :		8+1	6 mm ² :	2				
8 mm ² :		11+1	10 mm ² :	2				
	6 ... 10	6 mm ² :	8+1	6 mm ² :	2	6 10.5	2	4.7
		10 mm ² :	11+1	10 mm ² :	2			

Info

Insert	Wire gauge	Stripping length		Tightening torque		Max. cable insulation diameter	Size hexagon recess	Insert dimension for cable indication (ISK)
	(mm ²)	(mm)		(Nm)		(mm)	(SW)	(mm)
Han® C module with axial screw terminal	2.5 ... 8	2.5 mm ² :	5+1	2.5 mm ² :	1.5	4	2	5.2
		4 mm ² :	5+1	4 mm ² :	1.5	4		
6 mm ² :		8+1	6 mm ² :	2	6			
8 mm ² :		8+1	8 mm ² :	2	8.2			
	6 ... 10	6 mm ² :	8+1	6 mm ² :	2	6	2	5.2
		10 mm ² :	11+1	10 mm ² :	2	8.2		
Han® K3/0 straight	25 ... 40	25 mm ² :	22	25 mm ² :	8	15	5	8.2
		40 mm ² :	22	40 mm ² :	8			
	35 ... 70	35 mm ² :	22	35 mm ² :	8	15	5	8.2
		50 mm ² :	22	50 mm ² :	9			
		70 mm ² :	22	70 mm ² :	10			
Han® K3/0 angled	25 ... 40	25 mm ² :	22	25 mm ² :	8	15	5	9
		40 mm ² :	22	40 mm ² :	8			
	35 ... 70	35 mm ² :	22	35 mm ² :	8	15	5	9
		50 mm ² :	22	50 mm ² :	9			
		70 mm ² :	22	70 mm ² :	10			
Han® K3/2 straight	35 ... 70 PE: 25 ... 40	35 mm ² :	22	35 mm ² :	8	power: 15 PE: 10	5	power: 8.2 PE: 7.2
		50 mm ² :	22	50 mm ² :	9			
		70 mm ² :	22	70 mm ² :	10			
		PE:	14					
Han® K3/2 angled	25 ... 40	25 mm ² :	22	25 mm ² :	8	power: 15 PE: 10	5	power: 9.0 PE: 7.2
		40 mm ² :	22	40 mm ² :	8			
	35 ... 70 PE: 25 ... 40	35 mm ² :	22	35 mm ² :	8	power: 15 PE: 10	5	power: 9.0 PE: 7.2
		50 mm ² :	22	50 mm ² :	9			
		70 mm ² :	22	70 mm ² :	10			
Han® HC Modular 350	20 ... 35	20 mm ² :	19+1	20 mm ² :	8	19.5	5	13
		35 mm ² :	19+1	35 mm ² :	8			
	35 ... 70	35 mm ² :	19+1	35 mm ² :	8	19.5	5	13
		50 mm ² :	19+1	50 mm ² :	10			
		70 mm ² :	19+1	70 mm ² :	12			
	95 ... 120	95 mm ² :	19+1	95 mm ² :	14	19.5	5	13
		120 mm ² :	19+1	120 mm ² :	16			
Ground contact for Han® HC Modular	35 ... 70	35 mm ² :	19+1	35 mm ² :	8	-	5	-
		50 mm ² :	19+1	50 mm ² :	10			
		70 mm ² :	19+1	70 mm ² :	12			
Han® HC Modular 650	60 ... 70	60 mm ² :	23+2	60 mm ² :	12	27	8	28
		70 mm ² :	23+2	70 mm ² :	12			
	70 ... 120	70 mm ² :	23+2	70 mm ² :	12	26.5	8	28
		95 mm ² :	23+2	95 mm ² :	14			
		120 mm ² :	23+2	120 mm ² :	16			
	150 ... 185	150 mm ² :	23+2	150 mm ² :	17	26.5	8	28
		185 mm ² :	23+2	185 mm ² :	18			

Overview inserts with axial screw terminal

Insulating base dimension for the cable marking (ISK)

Marking the proper cable position for the axial screw connection contact point:

By marking the cable sheathing you can specify the proper point for tightening the axial screw on the connecting cable. If the cable is pushed into the insulating base up to the marker (where the marker is flush with the upper edge of the insulating base), then the cable is in the correct position for being connected. The following figure (on the next page) illustrates this process when using the Han® HC Modular 350 contact. The marker and the upper edge of the insulating base are at the same level (as indicated by the dashed line).

Info
00
·
16

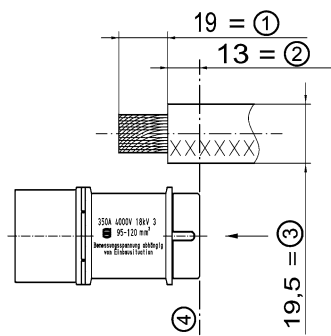

- ① stripping length
- ② insulator dimension (ISK dimension)
- ③ max. cable insulation diameter
- ④ sink line

Cage-clamp terminal

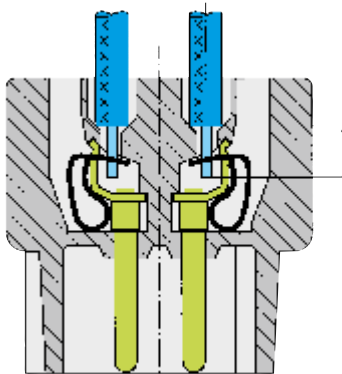

This termination method requires very little preparation of the wire and no special tools, leading to a low installed cost and a high degree of mechanical security.

- For all stranded and solid wires with a cross section 0.14 to 2.5 mm².
- Ease of termination. Conductor and screwdriver are in same plane.
- No special preparation of stripped conductor.
- The larger the conductor the higher the clamping force.
- The termination is vibration-proof.
- Guaranteed constant low resistance connection of the cage-clamp terminal.
- The cage-clamp system is internationally approved. VDE, CSA, UL, ÖVE, SEMKO, LCIE (France), Germanischer Lloyd, DET Norske Veritas

One conductor per termination Slot for screwdriver

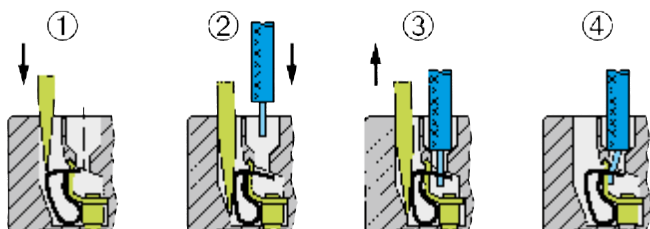
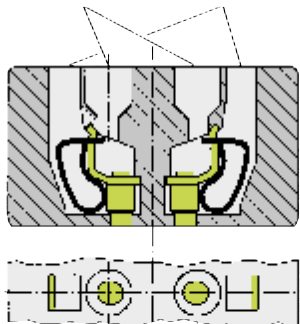

Screwdriver width: 0.6 x 3.5 mm

Kontakteinsätze	max. Leiterquerschnitt		Abisolierlänge l (mm)
	(mm ²)	AWG	
Han® ES, Han® Hv ES	0.14 ... 2.5	26 ... 14	7 ... 9
Han® ESS	0.14 ... 2.5	26 ... 14	9 ... 11
Han® ES Press	0.14 ... 2.5	26 ... 14	9 ... 11
Han® K 4/4	0.14 ... 2.5	26 ... 14	7 ... 9
Han® ES Modul	0.14 ... 2.5	26 ... 14	7 ... 9

Han® ES Press

The circular openings in the insert are used to hold the wire that is being connected. Note that there are two rows of rectangular holes (intended for plug-in jumpers) located between the contact openings of the Han® ES Press insert.

Note: Only one wire per termination point!

Each termination point is, in principle, only suited to hold a single wire. When required, two or more wires may be contacted per termination point; contact HARTING Technical Support first for more information.

Note!

An effective and durable spring clamp connection requires that the wire is properly stripped. The correct stripping lengths for the Han® ES Press contacts are specified in the table below, left side.

Assembly

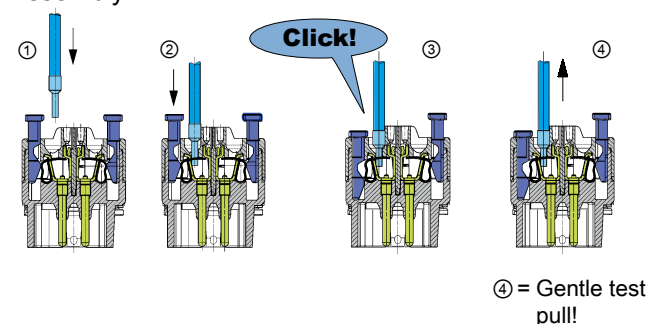

IDC (Insulation displacement terminal)

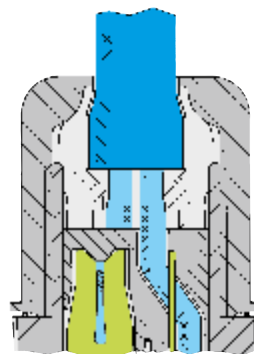

Inserts	max. wire gauge	
	(mm ²)	AWG
M8-S/M12-S	0.14 ... 0.34	26 ... 22
Circular connectors M12 angled	0.25 ... 0.50	24 (7/32) ... 22
Circular connectors M12-L	0.34 ... 0.75	22 ... 18
M12-L PROFIBUS	0.25 ... 0.34	24 ... 22
M12-L Ethernet	0.25 ... 0.34	24 ... 22
	0.34 ... 0.5	22 ... 18
Panel feed through Pg 13.5 /M20	0.75 ... 1.50	18 ... 16
Panel feed through Pg 9	0.25 ... 0.50	24 (7/32) ... 22
HARAX® 3 A	0.75 ... 1.5	18 ... 16

General

The choice of connectors entails more than just considering factors such as functionality, the number of contacts, current and voltage ratings. It is equally important to take account of where the connectors are to be used and the prevailing ambient conditions. This in turn means that, dependent on the conditions under which they are to be installed and pursuant to the relevant standards, different voltage and current ratings may apply for the same connectors.

The most important influencing factors and the corresponding electrical characteristics of the associated connectors are illustrated here in greater detail.

Overvoltage category

The overvoltage category is dependent on the mains voltage and the location at which the equipment is installed. It describes the maximum overvoltage resistance of a device in the event of a power supply system fault, e. g. in the event of a lightning strike.

The overvoltage category affects the dimensioning of components in that it determines the clearance air gap. Pursuant to the relevant standards, there are 4 overvoltage categories.

Equipment for industrial use, such as fall HARTING heavy duty Han connector, fall into Overvoltage Category III.

Extract from DIN VDE 0110-1 and IEC 60 664-1, Para. 2.2.2.1.1

Equipment of overvoltage category IV is for use at the origin of the installation.

Note 1: Examples of such equipment are electricity meters and primary overcurrent protection equipment.

Equipment of overvoltage category III is equipment in fixed installations and for cases where the reliability and the availability of the equipment is subject to special requirements.

Note 2: Examples of such equipment are switches in the fixed installation and equipment for industrial use with permanent connection to the fixed installation.

Equipment of overvoltage category II is energy-consuming equipment to be supplied from the fixed installation.

Note 3: Examples of such equipment are appliances, portable tools and other household equipment with similar loads.

If such equipment is subjected to special requirements with regard to reliability and availability, overvoltage category III applies.

Equipment of overvoltage category I is equipment for connection to circuits in which measures are taken to limit transient overvoltages to an appropriately low level.

Note: Examples are protected electronic circuits.

Rated impulse voltages (Table B2 of DIN EN 60 664-1)

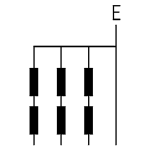
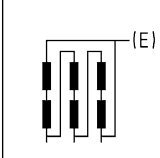
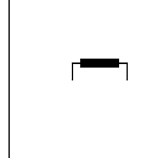
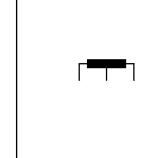
Voltage line-to-neutral derived from nominal voltages A.C. or D.C. up to and including	Nominal voltages presently used in the world (= Rated insulation voltage of equipment)				Rated impulse voltage for equipment			
	Three-phase 4-wire systems with earthed neutral	Three-phase 3-wire systems earthed or un-earthed	Single-phase 2-wire systems A.C. or D.C.	Single-phase 3-wire systems A.C. or D.C.	Overvoltage category			
					I Special protected levels	II Level for electrical equipment (household and others)	III Level for distribution supply systems	IV Input level
V	V	V	V	V	V	V	V	V
50			12.5 24 25 30 42 48	30 ... 60	330	500	800	1500
100	66/115	66	60		500	800	1500	2500
150	120/208* 127/220	115, 120 127	100** 110, 220	100 ... 200** 110 ... 220 120 .. 240	800	1500	2500	4000
300	220/380, 230/400 240/415, 260/440 277/480	200**, 220 230, 240 260, 277	220	220 ... 440	1500	2500	4000	6000
600	347/600, 380/660 400/690, 417/720 480/830	347, 380, 400 415, 440, 480 500, 577, 600	480	480 ... 960	2500	4000	6000	8000
1000		660 690, 720 830, 1000	1000		4000	6000	8000	12 000

* ... Practice in the U.S.A and in Canada

** ... Practice in Japan

Info

Pollution degree

The dimensioning of operating equipment is dependent on environmental conditions. Any pollution or contamination may give rise to conductivity that, in combination with moisture, may affect the insulating properties of the surface on which it is deposited. The pollution degree influences the design of components in terms of the creepage distance.

The pollution degree is defined for exposed, unprotected insulation on the basis of environmental conditions.

HARTING heavy duty Han connectors are designed as standard for Pollution Degree 3.

Pollution degree 1

in air-conditioned or clean, dry rooms, such as computer and measuring instrument rooms, for example.

Pollution degree 2

in residential, sales and other business premises, precision engineering workshops, laboratories, testing bays, rooms used for medical purposes. As a result of occasional moisture condensation, it is to be anticipated that pollution/contamination may be temporarily conductive.

Pollution degree 3

in industrial, commercial and agricultural premises, unheated storage premises, workshops or boiler rooms, also for the electrical components of assembly or mounting equipment and machine tools.

Pollution degree 4

in outdoor or exterior areas such as equipment mounted on the roofs of locomotives or tramcars.

Extract from DIN EN 60 664-1 (VDE 0110-1), Para. 4.6.2

Pollution degree 1: No pollution or only dry, non-conductive pollution occurs. The pollution has no influence.

Pollution degree 2: Only non-conductive pollution occurs except that occasionally a temporary conductivity caused by condensation is to be expected.

Pollution degree 3: Conductive pollution occurs or dry non-conductive pollution occurs which becomes conductive due to condensation which is to be expected.

Pollution degree 4: Continuous conductivity occurs due to conductive dust, rain or other wet conditions.

Special ruling for connectors

Subject to compliance with certain preconditions, the standard for connectors permits a lower pollution degree than that which applies to the installation as a whole. This means that in a pollution degree 3 environment, connectors may be used which are electrically rated for pollution degree 2.

The basis for this is contained in DIN EN 61 984, Para. 6.19.2.3.

Extract from DIN EN 61 984, Para. 6.19.2.3

For a connector with a degree of protection IP 54 or higher according to IEC 60 529 the insulating parts inside the enclosure may be dimensioned for a lower pollution degree.

This also applies to mated connectors where enclosure is ensured by the connector housing and which may only be disengaged for test and maintenance purposes.

The conditions fulfill,

- a connector which is protected to at least IP 54 as per IEC 60 529,
- a connector which is installed in a housing and which as described in the standard is disconnected for testing and maintenance purposes only,
- a connector which is installed in a housing and which when disconnected is protected by a cap or cover to at least IP 54,
- a connector located inside a switching cabinet to at least IP 54.

These conditions do not extend to connectors which when disconnected remain exposed to the industrial atmosphere for an indefinite period.

It should be noted that pollution can affect a connector from the inside of an installation outwards.

Typical applications in which to choose pollution degree 2 connectors:

- A connector serving a drive motor which is disconnected only for the purpose of replacing a defective motor, even when the plant or system otherwise calls for pollution degree 3.
- Connectors serving a machine of modular design which are disconnected for transport purposes only and enable rapid erection and reliable commissioning. In transit, protective covers or adequate packing must be provided to ensure that the connectors are not affected by pollution/contamination.
- Connectors located inside a switching cabinet to IP 54. In such cases, it is even possible to dispense with the IP 54 housings of the connectors themselves.

Specifying electrical data

Electrical data for connectors are specified as per DIN EN 61 984.

This example identifies a connector suitable for use in an unearthed power system or earthed delta circuit (see page 00.22, Table B2 of DIN EN 60 664-1):

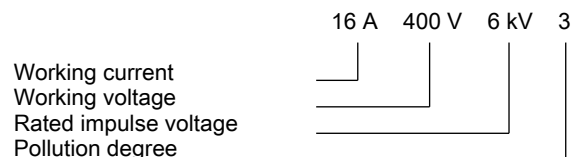

This example identifies a connector suitable exclusively for use in earthed power systems (see page 00.22, Table B2 of DIN EN 60 664-1):

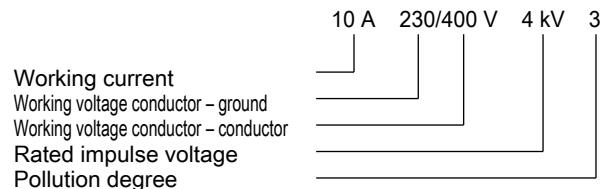

Other terms explained

Clearance air gap

The shortest distance through the air between two conductive elements (see DIN EN 60664-1 (VDE 0110-1), Para. 3.2). The air gaps are determined by the surge voltage withstand level.

Creepage distance

Shortest distance on the surface of an solid insulating material between two conductive elements (see DIN EN 60664-1 (VDE 0110-1), Para. 3.3). The creepage distances are dependent on the rated voltage, the pollution degree and the characteristics of the insulating material.

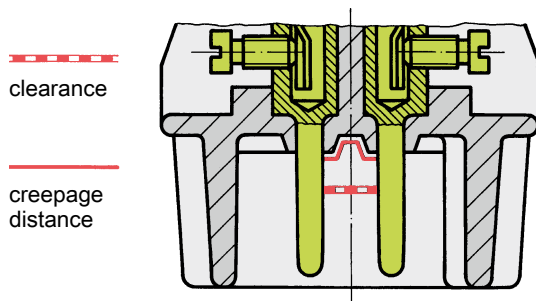

Working voltage

Fixed voltage value on which operating and performance data are based. More than one value for rated voltage or rated voltage range may be specified for the same connector.

Rated impulse voltage

The rated impulse voltage is determined on the basis of the overvoltage category and the nominal power supply voltage. This level in turn directly determines the test voltage for testing the overvoltage resistance of the connector (Waveform voltage in 1.2/50 μ s as per IEC 60060-1).

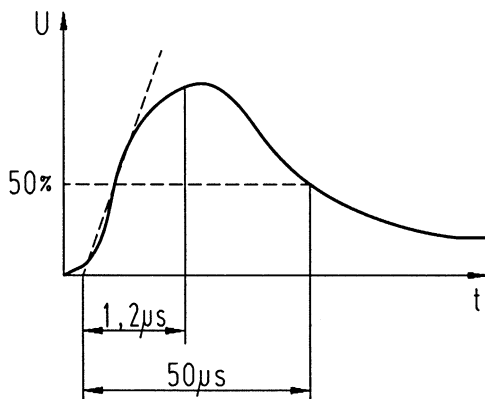

Working current

Fixed current, preferably at an ambient temperature of 40 °C, which the connector can carry on a permanent basis (without interruption), passing simultaneously through all contacts which are in turn connected to the largest possible voltage conductors, without exceeding the upper temperature limit.

The dependence of the rated current on ambient temperature is illustrated in the respective derating diagrams.

Transient overvoltages

Short-term overvoltage lasting a few milliseconds or less, oscillatory or non-oscillatory, generally heavily damped (see DIN EN 60664-1 (VDE 0110-1, Para. 3.7.2). An overvoltage may occur as a result of switching activities, a defect or lightning surge, or may be intentionally created as a necessary function of the equipment or component.

Power-frequency withstand voltage

A power-frequency overvoltage (50/60 Hz). Applied for a duration of one minute when testing dielectric strength. For test voltages in association with surge voltage withstand levels, see extract from Table 8, DIN EN 61984.

Test voltages (Extract from Table 8, DIN EN 61984)

Impulse withstand voltage kV (1.2/50 μ s) at an altitude of 2000 m	RMS withstand voltage kV (50/60 Hz)
0.5	0.37
0.8	0.50
1.5	0.84
2.5	1.39
4	2.21
6	3.31
8	4.26
12	6.6

CTI (Comparative Tracking Index)

This figure gives an indication of the conductivity of insulating materials and affects the specified creepage distances. The influence of the CTI value on the creepage distance is as follows: the higher the index value, the shorter the creepage distance. The CTI is used to divide plastics into insulation groups.

Breakdown of insulation groups:

- I 600 \leq CTI
- II 400 \leq CTI < 600
- IIIa 175 \leq CTI < 400
- IIIb 100 \leq CTI < 175

Protection levels as per IEC 60529

The protection level describes the leak-proof character of housing, e. g. for electrical equipment. It ranges from IP 00 to IP 68. HARTING heavy duty Han connectors feature a standard protection level of IP 65 (see page 00.5, table based on DIN EN 60529, IEC 60529).

Derating diagram as per DIN EN 60512-5-2

These diagrams are used to illustrate the maximum current carrying capacity of components. The illustration follows a curve which shows the current in relation to ambient temperature. Current carrying capacity is limited by the thermal characteristics of contacts and insulating elements which have an upper temperature limit which should not be exceeded.

Current carrying capacity

The current carrying capacity is determined in tests which are conducted on the basis of the DIN EN 60512-5-2. The current carrying capacity is limited by the thermal properties of materials which are used for inserts as well as by the insulating materials. These components have a limiting temperature which should not be exceeded. The connectors are tested in the assembled state, including hoods and housings.

The relationship between the current, the temperature rise (loss at the contact resistance) and the ambient temperature of the connector is represented by a curve. On a linear coordinate system the current lies on the vertical line (ordinate) and the ambient temperature on the horizontal line (abscissa) which ends at the upper limiting temperature. The rated current of a connector is usually specified at 40°C ambient temperature.

In another measurement the self-heating (Δt) at different currents is determined.

At least 3 points are determined which are connected to a parabolic curve, the basic curve.

The corrected current carrying capacity curve is derived from this basic curve. The reasons for the correction are external factors that bring an additional limitation to the current carrying capacity, i.e. connectable wire gauge or an unequal dispersion of current.

The derating diagrams pictured as curve have been primarily determined with tin-plated cables as well as with physical cross sections close to the respective ISO-cable cross section.

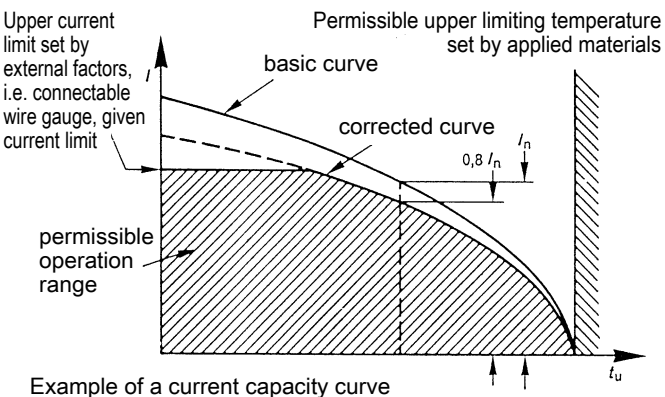

Definition: The rated current is the continuous, not interrupted current a connector can take when simultaneous power on all contacts is given, without exceeding the maximum temperature.

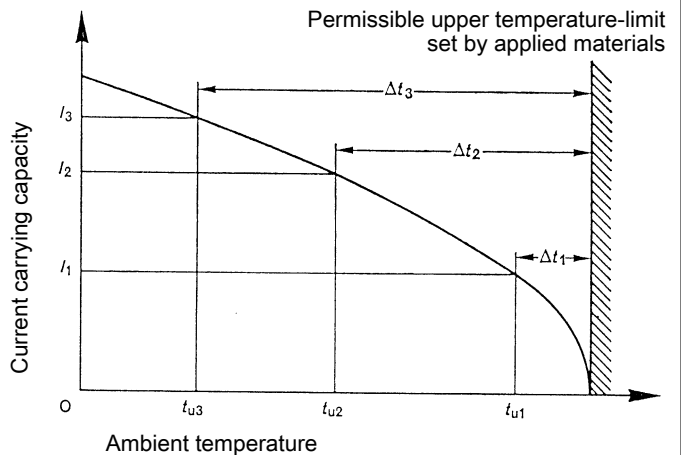

Acc. to DIN EN 61984 the sum of ambient temperature and the temperature rise of a connector shall not exceed the upper limiting temperature. During operation, the highest temperatures are caused by the current flow at the contact point of the connector.

The insulation material used must permanently withstand these limiting temperatures.

In practice it is not usual to load all terminals simultaneously with the maximum current. In such a case single contacts can be loaded with a higher current as permitted by the current capacity curve, if less than 20 % of the whole is loaded.

However, for these cases there are no universal rules. The limits have to be determined individually from case to case. It is recommended to proceed in accordance with the relevant rules of the DIN EN 60512-5-2.

Current carrying capacity of copper wires

Diameter [mm ²] of single wires in a three-phase system	0.75	1	1.5	2.5	4	6	10	16	25	35
Type of installation										
B1 Conductors/single core cables in conduit and cable trunking systems	8.6	10.3	13.5	18.3	24	31	44	59	77	96
B2 Cables in conduit and cable trunking systems	8.5	10.1	13.1	17.4	23	30	40	54	70	86
C Cables on walls	9.8	11.7	15.2	21	28	36	50	66	84	104
E Cables on open cable trays	10.4	12.4	16.1	22	30	37	52	70	88	110
Depiction in accordance with DIN EN 60204-1 for PVC-insulated copper wires in an ambient temperature of + 40 °C under permanent operating conditions.										
For different conditions and temperatures, installations, insulation materials or conductors the relevant corrections have to be carried out.										

Short-time current carrying capacity

A short-time overload in circuits can be generated by switching operations such as the starting of a motor or a short circuit in a faulty installation. This can cause thermal stress at the contact. These short and very high increases cannot be dissipated quickly and therefore a local heating effect at the contact is the result. Contact design is an important feature when transient currents are encountered. HARTING contacts are machined from solid material and are therefore relatively unaffected by short overloads when compared to stamped and formed designs. For guidance please see the table below.

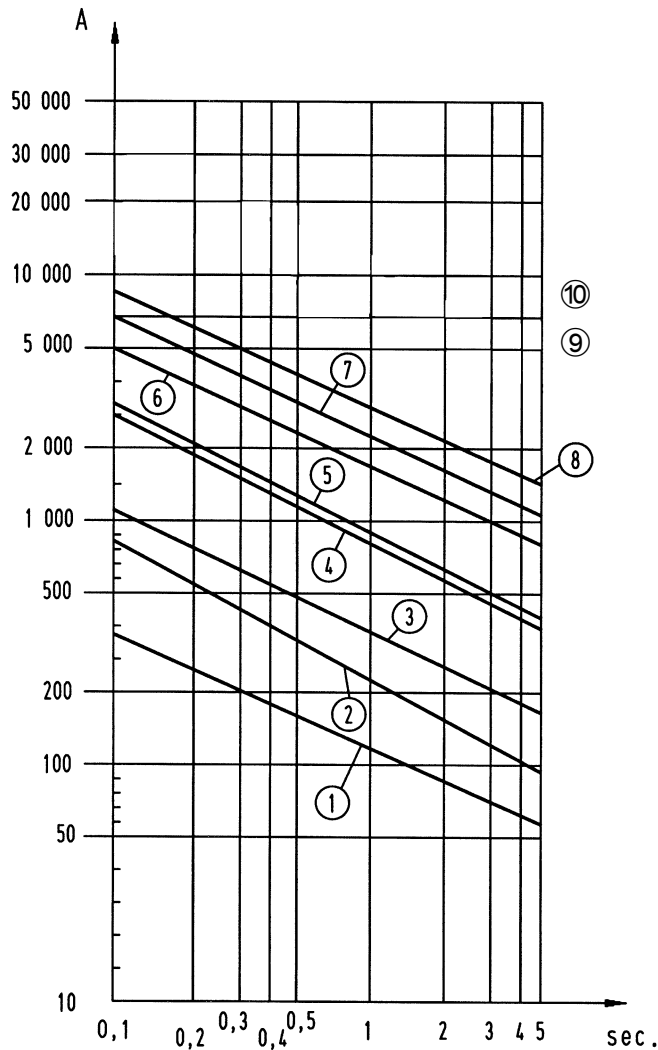

- | | |
|---------------------------------------|-----------------------|
| ① Han D® | $I_N = 10 \text{ A}$ |
| ② Han® 3 A / 4 A | $I_N = 10 \text{ A}$ |
| ③ Han A® / Han E®, Han® ES, EE, Q 5/0 | $I_N = 16 \text{ A}$ |
| ④ Han® 6 HsB | $I_N = 35 \text{ A}$ |
| ⑤ Han® C/K axial | $I_N = 40 \text{ A}$ |
| ⑥ Han® K 4/8, Han® 70 A Modul | $I_N = 80 \text{ A}$ |
| ⑦ Han® K 6/6 | $I_N = 100 \text{ A}$ |
| ⑧ Han® K 3/0 | $I_N = 200 \text{ A}$ |
| ⑨ Han® HC-Modular 350* | $I_N = 350 \text{ A}$ |
| ⑩ Han® HC-Modular 650* | $I_N = 650 \text{ A}$ |

* Technical Validation - Please contact your local HARTING subsidiary

Low currents and voltages

HARTING's standard contacts have a silver plated surface. This precious metal has excellent conductive properties. In the course of a contact's lifetime, the silver surface generates a black oxide layer due to its affinity to sulphur. This layer is smooth and very thin and is partly interrupted when the contacts are mated and unmated, thus guaranteeing very low contact resistances. In the case of very low currents or voltages small changes to the transmitted signal may be encountered. This is illustrated below where an artificially aged contact representing a twenty year life is compared with a new contact.

In systems where such a change to the transmitted signal could lead to faulty functions and also in extremely aggressive environments, HARTING recommend the use of gold plated contacts.

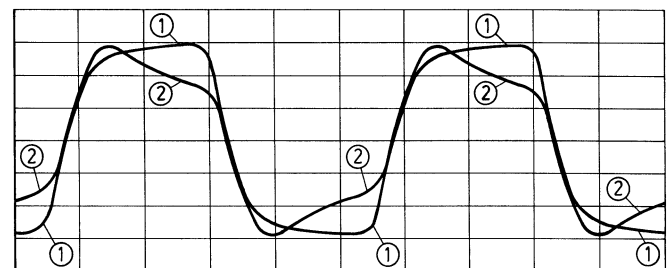

Changes to the transmitted signal after artificial ageing

- ① new contact
- ② after ageing

Below is a table derived from actual experiences.

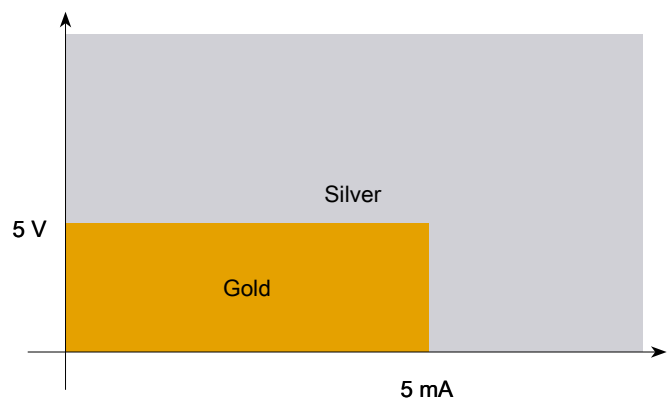

Recommendation

The metric thread is specified in the international DIN EN 50262 standard. The standard describes the metric series M 12 to M 63.

Info

The thread dimension in mm is given by the product type description. E.g. M 20 refers to 20 mm thread diameter.

For easy identification, metric threaded hoods and housings are marked with an **M**.

Cable range of metric glands:

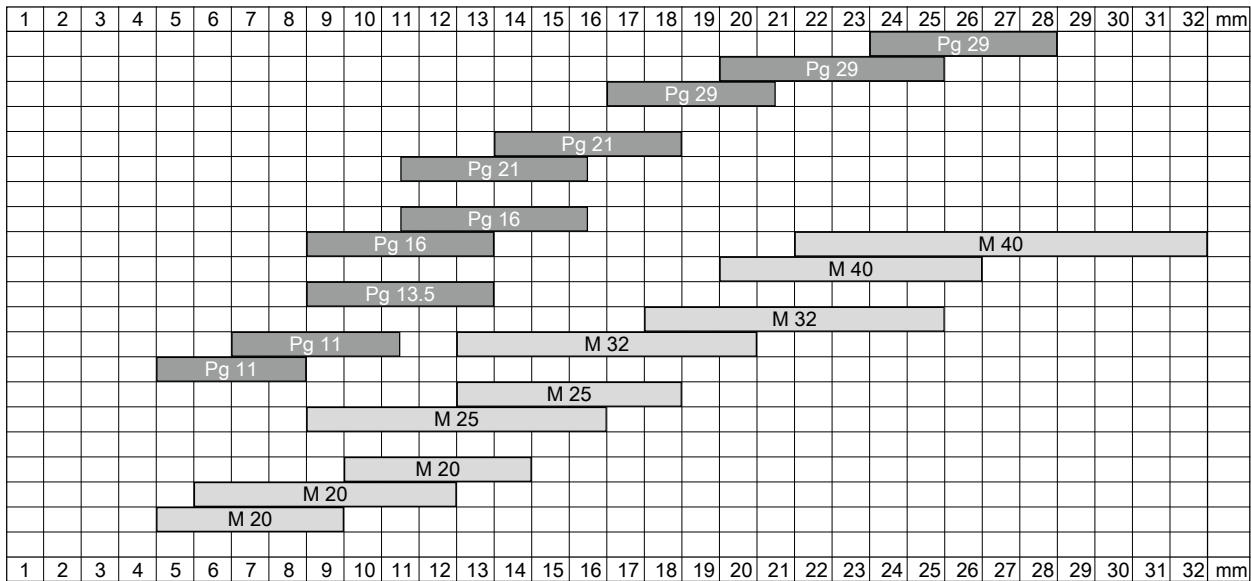

Cable

The diagram shows different cable-diameters, being dependent on wire gauges and number of conductors.

All data are averages for commercial cables.

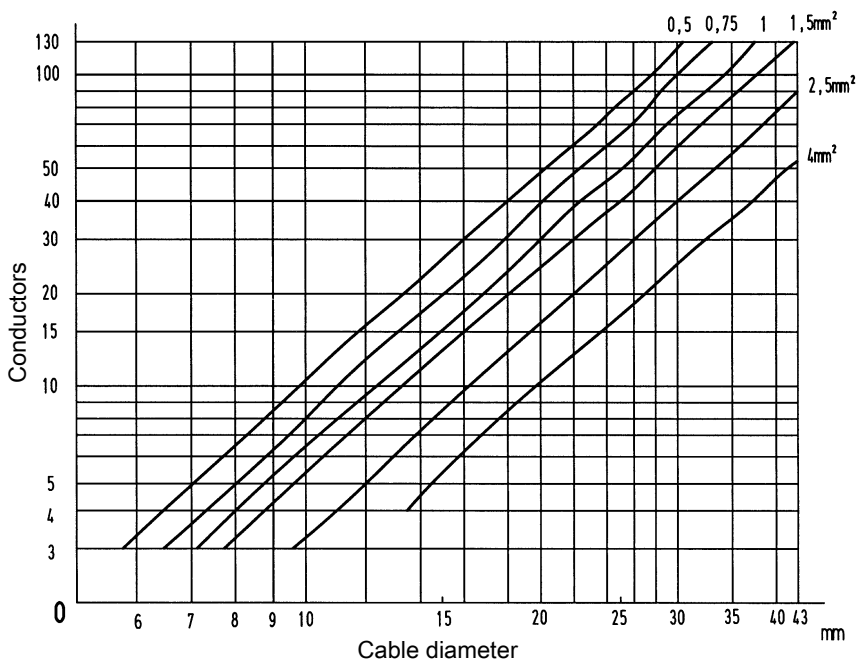



Supplier's Declaration of Conformity
(in accordance with ISO/IEC 17050-1)
Konformitätserklärung eines Anbieters
(nach ISO/IEC 17050-1)

Issuer's name:
Name des Ausstellers

HARTING Electric GmbH & Co. KG

Issuer's address:
Anschrift des Ausstellers

Wilhelm-Harting-Str. 1
32339 Espelkamp
Germany

Product(s):
Produkt(e):

Han A®
Han® B
Han-Brid®
Han-Com®
Han D®
Han D® AV
Han DD®
Han-Eco®

Han E®
Han E® AV
Han® EE
Han® EEE
Han® ES
Han® ESS
Han® HC Modular 350
Han® HPR

Han® HsB
Han® K 3/0
Han® K 3/2
Han® M
Han-Modular®
Han-Power®
Han® Q
Han-Yellock®
Han Staf®

The product(s) as described above are in conformity with the requirements of:

Die oben beschriebenen Produkte sind konform mit den folgenden Anforderungen:

IEC 61984 (2008-10)

Connectors - Safety requirements and tests
Steckverbinder - Sicherheitsanforderungen und Prüfungen

Espekamp,
 2016-05-18

Uwe Gräff
Managing Director

Espekamp,
 2016-05-18

Andre Beneke
Director Product & Industry
Segment Management

The given information reflects our current knowledge. It is based on statements and information of our suppliers and third parties. This declaration does not include guarantees of quality or durability. Topicality, completeness and accuracy of the content are subject to change without notice. The safety instructions are to be respected. The user is self-responsible for the evaluation of the information and the concrete measures derived from it. Besides that, HARTING is liable only for culpable, intentional or grossly negligent acting as long as no mandatory legal liability for damages of life, body, health or Product Liability Act exists.

Die vorstehenden Informationen spiegeln unseren derzeitigen Kenntnisstand, dem insbesondere die Aussagen und Informationen unserer Lieferanten und Dritter zugrunde liegen, wider, beinhalten jedoch keine Beschaffenheits- oder Haltbarkeitsgarantien. Im Hinblick auf Aktualität, Vollständigkeit und Richtigkeit der Inhalte behalten wir uns Änderungen jederzeit vor. Die Sicherheitshinweise sind zu beachten, wobei der Anwender für die Bewertung der Informationen und die hieraus abgeleitete konkrete Verwendung selbst verantwortlich ist. Im Übrigen haftet HARTING nur für schuldhaftes vorsätzliches oder grob fahrlässiges Handeln, soweit nicht eine zwingende gesetzliche Haftung für Schäden an Leben, Körper oder Gesundheit oder nach dem Produkthaftungsgesetz besteht.