

Contents	Page
Sockets.....	Han 12.2
Frames	Han 12.6
Data connectors	Han 12.10
Wires	Han 12.15
Gender changer.....	Han 12.18
Accessories	Han 12.19

Features

- Sockets for the European and international market
- Modular assembly
- Sockets to mount or snap into mounting plates

Technical characteristics

Mounting depth	62 mm, 30 mm, 20 mm, 43 mm
Supply voltage	250 V AC, 125 V AC, 240 V AC
Nominal frequency	50 Hz, 60 Hz
Nominal current	16 A, 15 A, 13 A, 5 A, 10 A
Material (hood/housing)	Thermoplastic
RoHS	compliant

Specifications and approvals

CE





Details

for detailed technical characteristics see following pages

Identification	Conductor cross-section (mm ²)	Part number	
Han-Port®, Socket, With LED display, Connection at the rear, Screw termination, Germany (VDE) , 62 mm / 250 V AC / 50 Hz / 16 A	6	39 50 001 0001	
Han-Port®, Socket, for assembly in front of main switch, Connection at the rear, Screw termination, Germany (VDE) , 62 mm / 250 V AC / 50 Hz / 16 A	6	39 50 001 0002	
Han-Port®, Socket, Finger safe, Screw termination, USA Japan , 30 mm / 125 V AC / 60 Hz / 15 A	2.5	39 50 001 0004	
Han-Port®, Socket, With LED display, Connection at the rear, Screw termination, France (UTE) , 62 mm / 250 V AC / 50 Hz / 16 A	6	39 50 001 0005	
Han-Port®, Socket, Finger safe, Screw termination, Great Britain (BS) , 30 mm / 250 V AC / 60 Hz, 50 Hz / 13 A	4	39 50 001 0006	
Han-Port®, Socket, Double, Finger safe, Screw termination, Italy (CEI 23-16) , 20 mm / 250 V AC / 50 Hz / 16 A	2.5	39 50 001 0007	

Han-Port

Identification	Conductor cross-section (mm ²)	Part number	
Han-Port®, Socket, Screw termination, Australia China , 20 mm / 240 V AC / 60 Hz, 50 Hz / 15 A	4	39 50 001 0009	
Han-Port®, Socket, Screw termination, India (IS) , 20 mm / 240 V AC / 50 Hz / 6 A	4	39 50 001 0321	
Han-Port®, Socket, Screw termination, Brazil , 30 mm / 250 V AC / 60 Hz / 10 A	2.5	39 50 001 0331	
Han-Port®, Socket, Screw termination, Israel , 30 mm / 250 V AC / 50 Hz / 16 A	2.5	39 50 001 0333	
Han-Port®, Socket, Spring clamp termination, Switzerland , 30 mm / 250 V AC / 50 Hz / 10 A	1.5	39 50 001 0012	
Han-Port®, Socket, Spring clamp termination, Denmark , 20 mm / 250 V AC / 50 Hz / 13 A	2.5	39 50 001 0017	

Identification	Conductor cross-section (mm ²)	Part number	
<p>Han-Port®, Socket, Spring clamp terminal, Screw termination, China , 43 mm / 250 V AC / 50 Hz / 10 A</p>	4	39 50 001 0458	
<p>Han-Port®, Socket, Screw termination, China , 43 mm / 250 V AC / 50 Hz / 10 A 1x RJ45 Cat.6 / 1x USB-A 3.0, enclosed separately</p>	4	39 50 012 0458	
<p>Han-Port®, Socket, Spring clamp terminal, Spring clamp termination, Germany (VDE) , 43 mm / 250 V AC / 50 Hz / 16 A</p>	2.5	39 50 001 0450	
<p>Han-Port®, Socket, Spring clamp termination, Germany (VDE) , 43 mm / 250 V AC / 50 Hz / 16 A 1x RJ45 Cat.6 / 1x USB-A 3.0, enclosed separately</p>	2.5	39 50 012 0450	

Features

- Suitable for rough industrial environments (degree of protection IP65 with closed cover)
- Modular assembly
- Various mounting plates with sockets and data interfaces available

Technical characteristics

Limiting temperature	-10 ... +60 °C
Storage temperature	-25 ... +60 °C
Degree of protection acc. to IEC 60529	IP65
Material (hood/housing)	Thermoplastic, Zinc die-cast
Surface (hood/housing)	Smoothed surface
RoHS	compliant



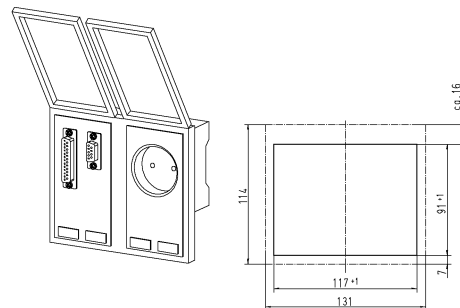
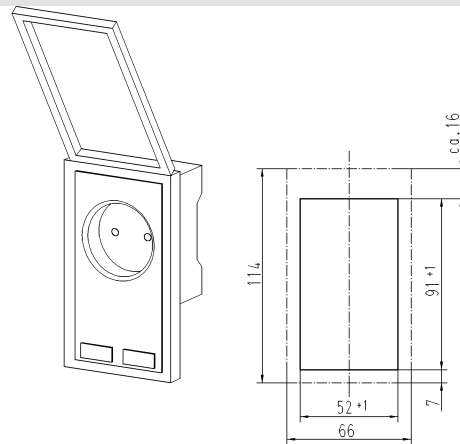

Specifications and approvals

UL 508 NITW2.E472460
 CSA-C22.2 No. 14-95 NITW8.E472460

Details



Han-Port

Identification	Part number	
Han-Port®, Frames, Single, Plastic version, PBT black, Plastic cover, PC transparent	39 50 000 0300	
Han-Port®, Frames, Double, Plastic version, PBT black, Plastic cover, PC transparent	39 50 000 0400	
Han-Port®, Frames, Single, Plastic version, PBT black, Plastic cover, ABS metallic silver	39 50 000 0320	
Han-Port®, Frames, Double, Plastic version, PBT black, Plastic cover, ABS metallic silver	39 50 000 0420	

Identification

Part number

Han-Port®,
Frames,
Single,
Metal version, nickel plated (electrically conductive),
Transparent plastic cover



39 50 000 0100



Han-Port®,
Frames,
Double,
Metal version, nickel plated (electrically conductive),
Transparent plastic cover

39 50 000 0200



Identification	Part number	
<p>Han-Port®, Frames, Single, Metal version, nickel plated (electrically conductive), Metal cover, nickel plated</p>	<p>39 50 000 0110</p>	
<p>Han-Port®, Frames, Double, Metal version, nickel plated (electrically conductive), Metal cover, nickel plated</p>	<p>39 50 000 0210</p>	
<p>Han-Port®, Frames, Single, Metal version, CPD black, Metal cover, CPD black</p>	<p>39 50 000 0120</p>	

Features

- Standard interfaces for easy connection of devices
- Modular assembly
- Assembled data connectors to snap into the frame
- Frames with or without shielding plate

Technical characteristics

RoHS	compliant, compliant with exemption
RoHS exemptions	6c: Copper alloy containing up to 4 % lead by weight

Specifications and approvals

UL 508 NRAQ2.E253944
CSA-C22.2 No. 142 NRAQ8.E253944



Details

D-Sub: < 125 V AC / 150 V DC / 3 A

Mounting depth 32 mm

RJ45: < 50 V AC/DC / 1 A

Mounting depth 32 mm

USB: < 30 V AC/DC / 1 A

Mounting depth 80 mm

Identification

Part number

Han-Port®,
Data connectors,
Without shielding plate,
D-Sub 1 (9-pin) female/male gender changer,
D-Sub 1 (9-pin) female/male gender changer

39 50 003 0020



Han-Port®,
Data connectors,
Without shielding plate,
D-Sub 1 (9-pin) female/female gender changer

39 50 003 0024



Han-Port®,
Data connectors,
Without shielding plate,
D-Sub 1 (9-pin) female/male gender changer,
D-Sub 3 (25-pin) female/male gender changer

39 50 003 0040



Han-Port®,
Data connectors,
Without shielding plate,
D-Sub 3 (25-pin) female/male gender changer

39 50 003 0074



Han-Port®,
Data connectors,
Without shielding plate,
RJ45 female/female gender changer, 8-pin, metal, Cat. 5e,
D-Sub 1 (9-pin) female/female gender changer,
D-Sub 1 (9-pin) male/male gender changer

39 50 003 0111



Han-Port®,
Data connectors,
Without shielding plate,
RJ45 female/female gender changer, 8-pin, metal, Cat. 5e,
D-Sub 1 (9-pin) male/male gender changer,
D-Sub 1 (9-pin) male/male gender changer,
D-Sub 1 (9-pin) male/male gender changer

39 50 003 0129



Han-Port

Identification

Part number

Han-Port®,
Data connectors,
Without shielding plate,
RJ45 female/female gender changer, 8-pin, metal, Cat. 5e,
D-Sub 1 (9-pin) female/male gender changer,
D-Sub 3 (25-pin) female/male gender changer

39 50 003 0170



Han-Port®,
Data connectors,
Without shielding plate,
D-Sub 1 (15-pin HD) female/male gender changer

39 50 003 0220



Identification

Part number

Han-Port®,
Data connectors,
With shielding plate,
USB female/female gender changer, size A according to specification 3.0,
USB female/female gender changer, size A according to specification 3.0

39 50 002 0093



Han-Port®,
Data connectors,
With shielding plate,
USB female/female gender changer, size A according to specification 3.0,
RJ45 female/female gender changer, 8-pin, metal, Cat. 5e,
D-Sub 1 (9-pin) male/male gender changer,
D-Sub 1 (9-pin) male/male gender changer

39 50 002 0117



Han-Port®,
Data connectors,
With shielding plate,
RJ45 female/female gender changer, 8-pin, metal, Cat. 5e,
RJ45 female/female gender changer, 8-pin, metal, Cat. 5e

39 50 002 0120



Han-Port®,
Data connectors,
With shielding plate,
RJ45 female/female gender changer, 8-pin, metal, Cat. 5e,
RJ45 female/female gender changer, 8-pin, metal, Cat. 5e,
RJ45 female/female gender changer, 8-pin, metal, Cat. 5e,
RJ45 female/female gender changer, 8-pin, metal, Cat. 5e

39 50 002 0122



Han-Port®,
Data connectors,
With shielding plate,
USB female/female gender changer, size A according to specification 3.0,
RJ45 female/female gender changer, 8-pin, metal, Cat. 5e,
RJ45 female/female gender changer, 8-pin, metal, Cat. 5e

39 50 002 0133



Han-Port®,
Data connectors,
With shielding plate,
USB female/female gender changer, size A according to specification 3.0,
RJ45 female/female gender changer, 8-pin, metal, Cat. 5e,
D-Sub 1 (9-pin) female/male gender changer

39 50 002 0143



Han-Port

Identification

Part number

Han-Port®,
Data connectors,
With shielding plate,
USB female/female gender changer, size A according to specification 3.0,
RJ45 female/female gender changer, 8-pin, metal, Cat. 5e,
D-Sub 3 (25-pin) female/male gender changer

39 50 002 0145



Han-Port®,
Data connectors,
With shielding plate,
RJ45 female/female gender changer, 8-pin, metal, Cat. 5e,
RJ45 female/female gender changer, 8-pin, metal, Cat. 5e,
D-Sub 1 (9-pin) female/female gender changer

39 50 002 0163



Han-Port®,
Data connectors,
With shielding plate,
USB female/female gender changer, size A according to specification 3.0,
USB female/female gender changer, size A according to specification 3.0,
RJ45 female/female gender changer, 8-pin, metal, Cat. 5e,
RJ45 female/female gender changer, 8-pin, metal, Cat. 5e

39 50 004 0097



D-Sub Standard Male With plastic hood
 D-Sub Standard Male With plastic hood

Han-Port

Technical characteristics



Number of cores	9
Connector 1	D-Sub, Standard, Male, With plastic hood
Connector 2	D-Sub, Standard, Male, With plastic hood, Female

Technical characteristics

RoHS compliant

Details

Other cable lengths on request!

Identification	Cable length	Part number	Drawing (dimensions in mm)
D-Sub, Standard, Copper cable (round), Pre-assembled on both sides, Male/male 	2 m	39 50 903 0010	
	5 m	39 50 903 0011	
D-Sub, Standard, Copper cable (round), Pre-assembled on both sides, Female/male 	2 m	39 50 903 0020	
	5 m	39 50 903 0021	

RJ45 Thermoplastic
RJ45 Thermoplastic

Han-
Port

Technical characteristics

Number of cores	8
Connector 1	RJ45, Thermoplastic
Connector 2	RJ45, Thermoplastic
Transmission characteristics	Cat. 6, Class E up to 250 MHz
RoHS	compliant

Details

Other cable lengths on request!

Identification	Cable length	Part number	Drawing (dimensions in mm)
RJ45, Copper cable (round), Pre-assembled on both sides 	2 m 5 m	39 50 903 0060 39 50 903 0061	

USB 2.0 Type A Male
 USB 2.0 Type A Male

Han-
Port

Technical characteristics

Connector 1	USB 2.0, Type A, Male
Connector 2	USB 2.0, Type A, Male
RoHS	compliant

Details

Other cable lengths on request!

Identification	Cable length	Part number	Drawing (dimensions in mm)
USB, Copper cable (round), Pre-assembled on both sides 	2 m 5 m	39 50 903 0050 39 50 903 0051	

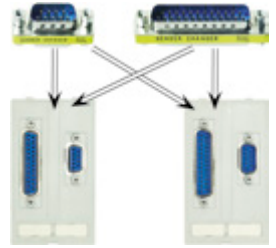

Technical characteristics

RoHS compliant

Identification	Part number	
Han-Port®, Gender changer, D-Sub 1, 9-pin, Female/female	39 50 904 0030	
Han-Port®, Gender changer, D-Sub 1, 9-pin, Female/male	39 50 904 0031	
Han-Port®, Gender changer, D-Sub 1, 9-pin, Male/male	39 50 904 0032	
Han-Port®, Gender changer, D-Sub 3, 25-pin, Female/female	39 50 904 0050	
Han-Port®, Gender changer, USB female/female gender changer, size A according to specification 3.0	39 50 904 0020	
Han-Port®, Gender changer, RJ45 female/female gender changer, 8-pin, metal, Cat. 5e	39 50 904 0010	

Technical characteristics

RoHS compliant

Specifications and approvals

UL 508 NRAQ2.E253944
CSA-C22.2 No. 142 NRAQ8.E253944

Identification

Part number

Han-Port®,
Identification strip,
Pack contents:
20 pieces per frame

39 50 000 0900



Han-Port®,
Blind plate,
With perforated cut-outs for gender changer RJ45, USB and
D-Sub 3

39 50 000 0851



Han-Port®,
Blind plate,
Free space for self assembly of connectors or switches: 45 x 75
mm

39 50 000 0890

