

Contents	Page
D-Sub adapter .....	<b>Han 80.2</b>
Locking levers.....	<b>Han 80.8</b>
Seals.....	<b>Han 80.10</b>
Han® Hood Link.....	<b>Han 80.12</b>
Panel feed through housings.....	<b>Han 80.13</b>
Accessories for flat cable entry.....	<b>Han 80.19</b>
Cable glands.....	<b>Han 80.20</b>
Shielding frame.....	<b>Han 80.26</b>
Grip frames.....	<b>Han 80.29</b>
Coding of inserts in hoods/housings.....	<b>Han 80.33</b>
Han® docking frame .....	<b>Han 80.38</b>
PE Multiple ground connection.....	<b>Han 80.40</b>
Strain relief clamp.....	<b>Han 80.41</b>
Special insert fixing screws .....	<b>Han 80.42</b>
Screws.....	<b>Han 80.43</b>
Bearing pedestal and covers .....	<b>Han 80.46</b>
Further accessories.....	<b>Han 80.47</b>

Accessories

Accessories







## Technical characteristics

Material (accessories)      Thermoplastic, Metal compliant  
RoHS

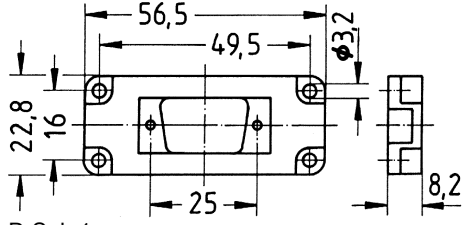
## Details

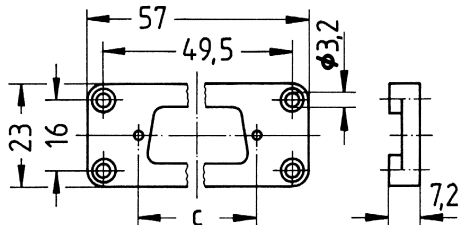
Not suitable for D-Sub High Density!

Identification	Part number	Drawing (dimensions in mm)
<p>D-Sub 1, Adapter plate, for 1 x D-Sub, Pack contents: 1 adapter, 4 fixing screws for adapter, 2 fixing screws for D-Sub connector</p> 	<p>09 20 000 9932</p>	 <p>D-Sub 1</p>
<p>D-Sub 2, Adapter plate, for 1 x D-Sub, Pack contents: 1 adapter, 4 fixing screws for adapter, 2 fixing screws for D-Sub connector</p> 	<p>09 20 000 9928</p>	 <p>D-Sub 2 c= 33.3 mm D-Sub 3 c= 47 mm</p>
<p>D-Sub 3, Adapter plate, for 1 x D-Sub, Pack contents: 1 adapter, 4 fixing screws for adapter, 2 fixing screws for D-Sub connector</p> 	<p>09 20 000 9929</p>	

Identification	Part number	Drawing (dimensions in mm)
<p>D-Sub 3 in the Han® 10 A, D-Sub 4 in the Han® 16 A, Adapter plate, for 1 x D-Sub, Metal,</p> <p>Pack contents: Two-piece adapter, 2 fixing screws for adapter, 2 fixing screws for D-Sub connector</p> <div data-bbox="635 560 790 660" data-label="Image"> </div>	<p>09 20 000 9925</p>	<div data-bbox="1005 336 1436 548" data-label="Diagram"> </div>

Accessories

Accessories





## Technical characteristics

Material (accessories)      Thermoplastic, Metal  
RoHS                              compliant

## Details

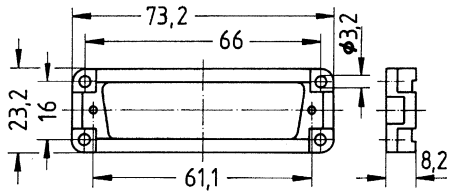
Not suitable for D-Sub High Density!

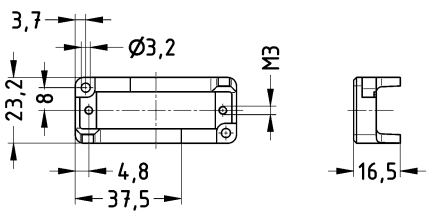
Identification	Part number	Drawing (dimensions in mm)
<p>D-Sub 5, Adapter plate, for 1 x D-Sub, Pack contents: 1 adapter, 4 fixing screws for adapter, 2 fixing screws for D-Sub connector</p> 	<p>09 20 000 9931</p>	
<p>D-Sub 3 in the Han® 10 A, D-Sub 4 in the Han® 16 A, Adapter plate, for 1 x D-Sub, Metal, Pack contents: Two-piece adapter, 2 fixing screws for adapter, 2 fixing screws for D-Sub connector</p> 	<p>09 20 000 9925</p>	



Accessories

## Technical characteristics

Material (accessories) Thermoplastic compliant  
RoHS

## Details

Not suitable for D-Sub High Density!

### Identification

### Part number

### Drawing (dimensions in mm)

D-Sub 1,  
Adapter plate,  
for 1 x D-Sub,  
Pack contents:  
1 adapter,  
4 fixing screws for adapter,  
2 fixing screws for D-Sub connector

09 30 000 9965

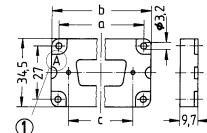

① Mounting in housing: character A visible  
② Mounting in hood: character T visible  
D-Sub 1: a=44; b=51.5; c=25  
D-Sub 2: a=44; b=51.5; c=33.3

D-Sub 2,  
Adapter plate,  
for 1 x D-Sub,  
Pack contents:  
1 adapter,  
4 fixing screws for adapter,  
2 fixing screws for D-Sub connector

09 30 000 9966

D-Sub 1,  
Adapter plate,  
for 2x D-Sub,  
Pack contents:  
1 adapter,  
4 fixing screws for adapter,  
4 fixing screws for D-Sub connector

09 30 000 9970

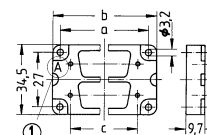

① Mounting in housing: character A visible  
② Mounting in hood: character T visible  
D-Sub 2x 1: a=44; b=51.5; c=25  
D-Sub 2x 2: a=44; b=51.5; c=33.3



D-Sub 2,  
Adapter plate,  
for 2x D-Sub,  
Pack contents:  
1 adapter,  
4 fixing screws for adapter,  
4 fixing screws for D-Sub connector

09 30 000 9971

Accessories



## Technical characteristics

Material (accessories)      Thermoplastic compliant  
RoHS

## Details

Not suitable for D-Sub High Density!

Identification	Part number	Drawing (dimensions in mm)
<p>D-Sub 3, Adapter plate, for 1 x D-Sub, Pack contents: 1 adapter, 4 fixing screws for adapter, 2 fixing screws for D-Sub connector</p>	<p>09 30 000 9967</p>	<p>① Mounting in housing: character A visible ② Mounting in hood: character T visible D-Sub 3: a=57; b=64.5; c=47</p>
<p>D-Sub 3, Adapter plate, for 2x D-Sub, Pack contents: 1 adapter, 4 fixing screws for adapter, 4 fixing screws for D-Sub connector</p> 	<p>09 30 000 9972</p>	<p>① Mounting in housing: character A visible ② Mounting in hood: character T visible D-Sub 2x 3: a=57; b=64.5; c=47</p>



Accessories

## Technical characteristics

Material (accessories) Thermoplastic compliant  
RoHS

## Details

Not suitable for D-Sub High Density!

Identification	Part number	Drawing (dimensions in mm)
<p>D-Sub 4, Adapter plate, for 1 x D-Sub, Pack contents: 1 adapter, 4 fixing screws for adapter, 2 fixing screws for D-Sub connector</p>	09 30 000 9968	<p>① Mounting in housing: character A visible ② Mounting in hood: character T visible D-Sub 4: a=77.5; b=85; c=63.5 D-Sub 5: a=77.5; b=85; c=61.1</p>
<p>D-Sub 5, Adapter plate, for 1 x D-Sub, Pack contents: 1 adapter, 4 fixing screws for adapter, 2 fixing screws for D-Sub connector</p>	09 30 000 9969	
<p>D-Sub 4, Adapter plate, for 2x D-Sub, Pack contents: 1 adapter, 4 fixing screws for adapter, 4 fixing screws for D-Sub connector</p>	09 30 000 9973	<p>① Mounting in housing: character A visible ② Mounting in hood: character T visible D-Sub 2x 4: a=77.5; b=85; c=63.5 D-Sub 2x 5: a=77.5; b=85; c=61.1</p>
<p>D-Sub 5, Adapter plate, for 2x D-Sub, Pack contents: 1 adapter, 4 fixing screws for adapter, 4 fixing screws for D-Sub connector</p>	09 30 000 9974	



Double locking lever



Accessories

## Technical characteristics

Material (accessories) Polycarbonate (PC), Stainless steel  
 Colour (accessories) RAL 7037 (dust grey)

## Technical characteristics

Material flammability class acc. to UL 94 (locking levers) V-0  
 RoHS compliant

Identification	Size	Part number	Drawing (dimensions in mm)
Han A®, Han-Easy Lock®, Locking levers, RAL 7037 (dust grey) 	32 A	09 00 000 5223	
Han® B, Han-Easy Lock®, Locking levers, RAL 7037 (dust grey) 	10/16/24 B 32 B	09 00 000 5221 09 00 000 5231	



Single locking lever







Accessories

## Technical characteristics

Material (accessories) Thermoplastic, Polycarbonate (PC), Stainless steel  
 Colour (accessories) RAL 7032 (pebble grey), Black, RAL 7037 (dust grey)

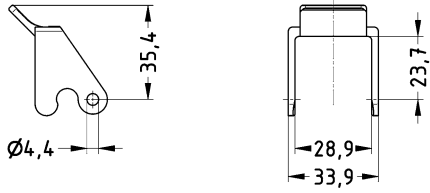
## Technical characteristics

Material flammability class acc. to UL 94 (locking levers) V-0  
 RoHS compliant

Identification	Size	Part number	Drawing (dimensions in mm)
Locking levers, RAL 7032 (pebble grey)	3 A	09 00 000 5241	
			
Locking levers, Black	3 A	09 00 000 5242	
			
Locking levers, Han® Q 8/0, Black	Han-Compact®	09 00 000 5244	
			
Han A®, Han-Easy Lock®, Locking levers, RAL 7037 (dust grey)	10 A 16 A	09 00 000 5224 09 00 000 5225	
			
Han® B, Han-Easy Lock®, Locking levers, RAL 7037 (dust grey)	06 B 10 B 16 B 24 B	09 00 000 5222 09 00 000 5228 09 00 000 5229 09 00 000 5230	
			



## Technical characteristics

Material (seal) NBR, FPM  
 Colour (seal) Black, Light grey

## Technical characteristics

RoHS compliant with exemption, compliant

Identification	Size	Part number	Drawing (dimensions in mm)
Han A®, Flange gasket	03 A	09 20 000 9991	
	10 A	09 20 000 9992	
	16 A	09 20 000 9993	
	32 A	09 20 000 9994	
Han® B, Flange gasket	06 B	09 30 000 9991	
	10 B	09 30 000 9992	
	16 B	09 30 000 9993	
	24 B	09 30 000 9994	
Han® B, Flange gasket, Self-retaining	06 B	09 30 000 9801	
	10 B	09 30 000 9802	
	16 B	09 30 000 9803	
	24 B	09 30 000 9804	
Flange gasket	48 HPR Han-Drive® Modular Compact	09 30 000 9996	
		09 30 000 9903	
		09 14 000 9940	
Flange gasket, Han® HPR	03 HPR	09 40 000 9980	
	06 HPR	09 40 000 9801	
	10 HPR	09 40 000 9802	
	16 HPR	09 40 000 9803	
	24 HPR	09 40 000 9804	
Han A®, Flange gasket, FPM	3 A	09 37 000 9912	
Han® M, Flange gasket, FPM	06 B	09 37 000 9946	
	10 B	09 37 000 9947	
	16 B	09 37 000 9948	
	24 B	09 37 000 9949	

## Technical characteristics

Material (seal) NBR, FPM

## Technical characteristics

Colour (seal) Black, RAL 7001 (silver-grey)  
RoHS compliant

Identification	Size	Part number	Drawing (dimensions in mm)
Han A®, Profile gasket	03 A	09 70 000 9991	
	10 A	09 20 000 9996	
	16 A	09 20 000 9997	
Han® B, Profile gasket	06 B	09 30 000 9941	
	10 B	09 30 000 9942	
	16 B	09 30 000 9943	
	24 B	09 30 000 9944	
	32 B	09 30 000 9963	
	48 B	09 30 000 9995	
Han® HPR, O-ring rubber seal	03 HPR	09 40 000 9910	
	06 HPR	09 40 000 9911	
	10 HPR	09 40 000 9912	
	16 HPR	09 40 000 9913	
	24 HPR	09 40 000 9914	
L-seal	06 B	09 30 000 9936	
	10 B	09 30 000 9935	
	16 B	09 30 000 9934	
	24 B	09 30 000 9933	
Profile gasket, FPM	03 A	09 21 000 9906	
	06 B	09 30 000 9951	
	10 B	09 30 000 9952	
	16 B	09 30 000 9953	
	24 B	09 30 000 9954	

Accessories

### Features

- Cable to cable connection simple to realise and easy to mount
- Resistant elastomer
- Locking as well as seal combined in one system
- for two lever locking system

### Technical characteristics

Limiting temperature	-40 ... +85 °C
Degree of protection acc. to IEC 60529	IP65, locked condition
Colour (hood/housing)	Black
RoHS	compliant

Identification	Part number	Drawing (dimensions in mm)
<p>Locking element, for hoods, IP65 locked condition</p> 	<p>09 30 016 9901</p>	

Standard hoods/housings for industrial connectors  
Double locking lever



Accessories

## Features

- Allows the entry of pre-assembled cables into a switch cabinet
- Robust design
- High pole cable entry seals for up to 10 different cables
- For sealing and feed through of pre-assembled cables

## Technical characteristics

Limiting temperature	-40 ... +125 °C
Degree of protection acc. to IEC 60529	IP65
Material (hood/housing)	Aluminium die-cast
Material (seal)	NBR
RoHS	compliant

## Specifications and approvals

CE

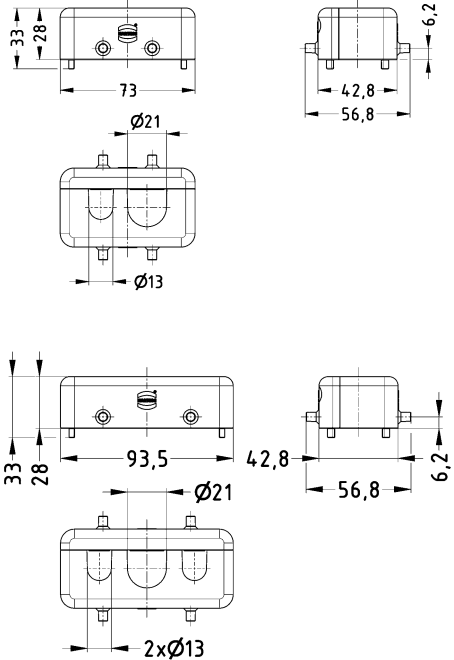
Identification	Cable entry	Size	Part number High construction	Drawing (dimensions in mm)
<p>Han® B, Panel feed through housing, Top entry, IP65</p> <p>Pack contents: 2 split hood halves, 2x M4 screw</p>  <p>Please order cable entry seals separately.</p>	<p>2x 3x</p>	<p>10 B 16 B</p>	<p>09 30 010 0498 09 30 016 0498</p>	

Accessories

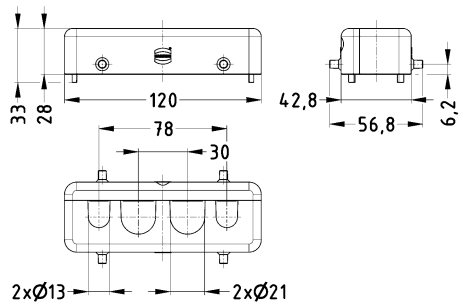





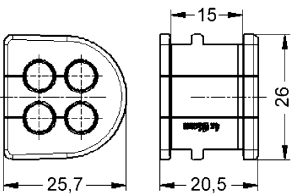

Identification	Cable entry	Size	Part number High construction	Drawing (dimensions in mm)
<p>Han® B, Panel feed through housing, Top entry, IP65</p> <p>Pack contents: 2 split hood halves, 3x M4 screw</p>  <p>Please order cable entry seals separately.</p>	<p>4x</p>	<p>24 B</p>	<p>09 30 024 0498</p>	

## Technical characteristics

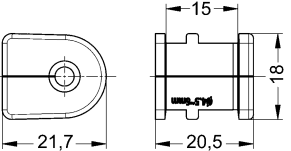
Material (accessories) NBR

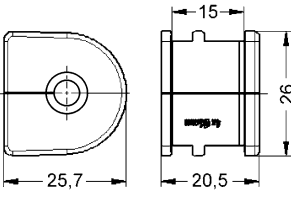
## Technical characteristics

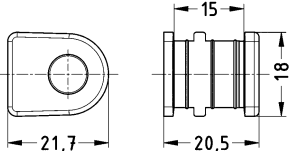
Colour (accessories) Black  
RoHS compliant

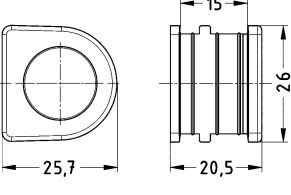
Identification	Clamping range (mm)	Part number	Drawing (dimensions in mm)
Cable entry seal, 4 cable entries, Wide version  	... 6	09 00 000 6004	
Cable entry seal, 1 cable entry, Narrow version  	4.5 ... 6 6 ... 7.5 7.5 ... 9	09 00 000 6005 09 00 000 6006 09 00 000 6007	
Cable entry seal, 1 cable entry, Wide version  	9 ... 10.5 10.5 ... 12 12 ... 13.5 13.5 ... 15 15 ... 16	09 00 000 6008 09 00 000 6009 09 00 000 6010 09 00 000 6011 09 00 000 6012	
Dummy plugs, Narrow version  		09 00 000 6101	
Dummy plugs, Wide version  		09 00 000 6102	

Standard hoods/housings for industrial connectors  
Double locking lever

Accessories



## Features

- Allows the entry of pre-assembled cables into a switch cabinet
- Use of identification strips is possible
- No special tools required
- Standard screw driver (5 x 1 mm) necessary to open split hood
- IP54 due to continuous contoured seal

## Technical characteristics

Limiting temperature	-40 ... +125 °C
Degree of protection acc. to IEC 60529	IP65
Type rating acc. to UL 50 / UL 50E	4, 4X, 12
Material (hood/housing)	Polycarbonate (PC)
Colour (hood/housing)	RAL 7037 (dust grey)
RoHS	compliant

## Specifications and approvals

UL 1977 ECBT2.E235076  
CSA-C22.2 No. 182.3 ECBT8.E235076

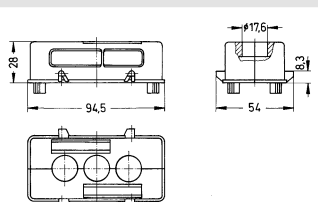
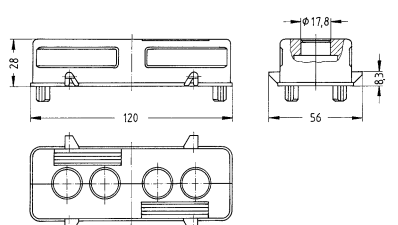

Identification	Cable entry	Cable diameter (mm)	Size	Part number	Drawing (dimensions in mm)
Han® B, Panel feed through housing, Top entry, IP65 Pack contents: 2 split hood halves    Please order cable entry seals separately. IP54 when mounted vertically	3x Integrated 4x Integrated	17.6 17.8	16 B 24 B	09 30 016 0408 09 30 024 0408	 <p>09 30 016 0301 Han® 16 B See chapter Han 31</p>  <p>09 30 024 0301 Han® 24 B See chapter Han 31</p>

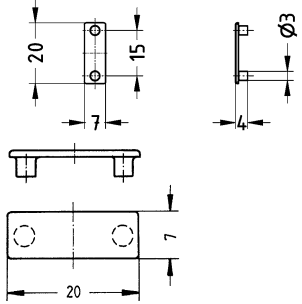

Identification	Cable entry	Cable diameter (mm)	Size	Part number	Drawing (dimensions in mm)
<p>Han-Snap<sup>®</sup>, Identification strip</p> 				09 33 000 9981	

Accessories

Accessories

## Technical characteristics

Material (accessories) Thermoplastic, NBR

## Technical characteristics

Colour (accessories) Black  
RoHS compliant

Identification	Clamping range (mm)	Part number	Drawing (dimensions in mm)
----------------	---------------------	-------------	----------------------------

Cable entry seal



3 ... 4  
4 ... 5  
5 ... 6  
6 ... 7  
7 ... 8  
8 ... 9  
9 ... 10

09 00 000 5351  
09 00 000 5352  
09 00 000 5353  
09 00 000 5354  
09 00 000 5355  
09 00 000 5356  
09 00 000 5357

Cable entry seal,  
Additional strain relief can be provided by  
cable ties (max. width 8 mm)



10 ... 11  
11 ... 12  
12 ... 13  
13 ... 14  
14 ... 15  
15 ... 16

09 00 000 5358  
09 00 000 5359  
09 00 000 5360  
09 00 000 5361  
09 00 000 5362  
09 00 000 5363

Cable entry seal,  
for ASI cable



09 00 000 5364

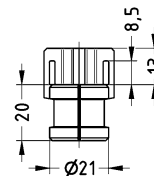

Dummy plugs



4.5 ... 6

09 00 000 5350  
09 00 000 6103

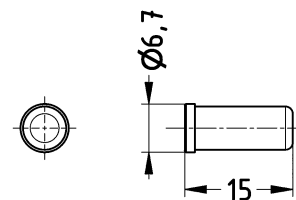
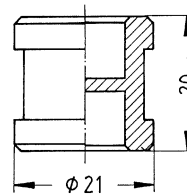





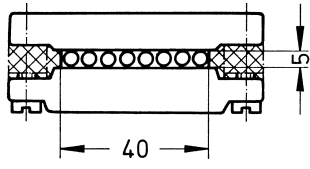

## Technical characteristics

Material (seal) NBR

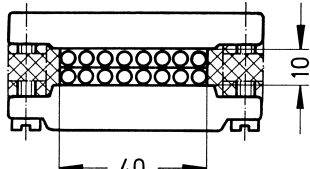
## Technical characteristics

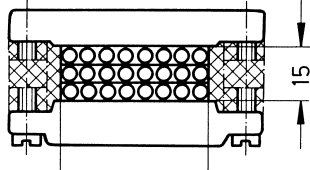
Colour (seal) Black  
RoHS compliant

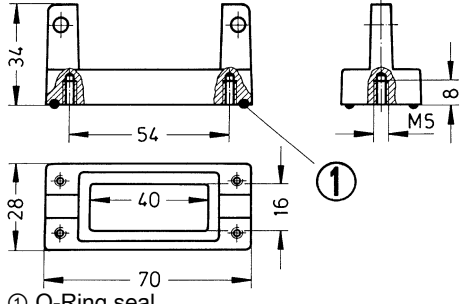
Identification	Part number	Drawing (dimensions in mm)
<p>Set of seals for ribbon cable entry, With strain relief clamp, for 1 flat cable</p> 	09 00 000 5315	
<p>Set of seals for ribbon cable entry, With strain relief clamp, for 2 flat cables</p> 	09 00 000 5316	
<p>Set of seals for ribbon cable entry, With strain relief clamp, for 3 flat cables</p> 	09 00 000 5317	
<p>Holder for ribbon cable entry, for separate mounting</p> 	09 00 000 5325	 <p>① O-Ring seal</p>

Accessories

## Technical characteristics

Limiting temperature	-40 ... +100 °C
Degree of protection acc. to IEC 60529	IP68, IP69 / IPX9K acc. to ISO 20653
Material (seal)	NBR
Material (cable glands)	Polyamide (PA)
Colour (accessories)	RAL 5012 (light blue), RAL 9005 (jet black), RAL 7032 (pebble grey), RAL 7035 (light grey)

## Technical characteristics

Material flammability class acc. to UL 94 V-0  
RoHS compliant

## Specifications and approvals

DNV GL  
UL 514B QCRV.E479780  
CSA-C22.2 No. 18.3 QCRV7.E479780

Identification	Size	Clamping range (mm)	Part number	Drawing (dimensions in mm)
----------------	------	---------------------	-------------	----------------------------

Han® CGM-Ex i,  
Cable gland,  
Intrinsically safe electric circuits,  
Blue,  
IP68,  
IP69 / IPX9K acc. to ISO 20653

M20	5 ... 9
M20	6 ... 12
M25	9 ... 16
M32	13 ... 20
M40	22 ... 32

19 00 000 7101
19 00 000 7102
19 00 000 7104
19 00 000 7106
19 00 000 7109

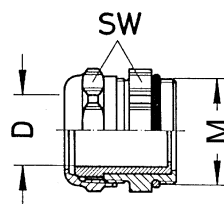

Han® CGM-P,  
Cable gland,  
Grey,  
IP68,  
IP69 / IPX9K acc. to ISO 20653



M20	5 ... 9
M20	6 ... 12
M20	10 ... 14
M25	9 ... 16
M25	13 ... 18
M32	13 ... 18
M32	18 ... 25
M40	20 ... 26
M40	22 ... 32

19 00 000 5180
19 00 000 5182
19 00 000 5184
19 00 000 5190
19 00 000 5192
19 00 000 5194
19 00 000 5196
19 00 000 5197
19 00 000 5198

Clamping range Ø	SW	E	Nm
5 ... 9 mm	24	26.4	4.5
6 ... 12 mm	24	26.4	4.5
10 ... 14 mm	27	29.8	4.5
9 ... 16 mm	33	33.5	5
13 ... 18 mm	33	36.5	5
13 ... 20 mm	42	46.8	6.5
18 ... 25 mm	42	46.8	6.5
20 ... 26 mm	53	58.8	10
22 ... 32 mm	53	58.8	10

Han® CGM-P,  
Cable gland,  
Black,  
IP68,  
IP69 / IPX9K acc. to ISO 20653



M20	5 ... 9
M20	6 ... 12
M20	10 ... 14
M25	9 ... 16
M25	13 ... 18
M32	13 ... 20
M32	18 ... 25
M40	20 ... 26
M40	22 ... 32

19 00 000 5181
19 00 000 5183
19 00 000 5185
19 00 000 5191
19 00 000 5193
19 00 000 5186
19 00 000 5187
19 00 000 5188
19 00 000 5189

## Technical characteristics

Limiting temperature	-40 ... +100 °C
Degree of protection acc. to IEC 60529	IP68, IP69 / IPX9K acc. to ISO 20653
Material (seal)	NBR, EPDM
Material (cable glands)	Brass
Material (clamping ring)	Polyamide (PA)
Surface (accessories)	Nickel plated
RoHS	compliant with exemption

## Specifications and approvals

UL 514B QCRV.E479780  
 CSA-C22.2 No. 18.3 QCRV7.E479780  
 DNV GL

Identification	Size	Clamping range (mm)	Part number	Drawing (dimensions in mm)																																																												
Han® CGM-M, Cable gland, IP68, IP69 / IPX9K acc. to ISO 20653	M20	5 ... 9	19 00 000 5080	<table border="1"> <thead> <tr> <th>Outer cable Ø</th> <th>SW</th> <th>E</th> <th>Nm</th> </tr> </thead> <tbody> <tr><td>5 ... 9 mm</td><td>22</td><td>24.4</td><td>10</td></tr> <tr><td>5 ... 12 mm</td><td>22</td><td>24.4</td><td>10</td></tr> <tr><td>6 ... 12 mm</td><td>22</td><td>24.4</td><td>10</td></tr> <tr><td>10 ... 14 mm</td><td>24</td><td>26.4</td><td>10</td></tr> <tr><td>9 ... 16 mm</td><td>30</td><td>33.5</td><td>12</td></tr> <tr><td>9 ... 18 mm</td><td>30</td><td>33.5</td><td>12</td></tr> <tr><td>13 ... 18 mm</td><td>30</td><td>33.5</td><td>12</td></tr> <tr><td>13 ... 20 mm</td><td>40</td><td>44</td><td>15</td></tr> <tr><td>13 ... 25 mm</td><td>40</td><td>44</td><td>15</td></tr> <tr><td>18 ... 25 mm</td><td>40</td><td>44</td><td>15</td></tr> <tr><td>20 ... 26 mm</td><td>50</td><td>55</td><td>15</td></tr> <tr><td>22 ... 32 mm</td><td>50</td><td>55</td><td>15</td></tr> <tr><td>20 ... 32 mm</td><td>50</td><td>55</td><td>15</td></tr> <tr><td>32 ... 38 mm</td><td>57</td><td>60</td><td>24</td></tr> </tbody> </table>	Outer cable Ø	SW	E	Nm	5 ... 9 mm	22	24.4	10	5 ... 12 mm	22	24.4	10	6 ... 12 mm	22	24.4	10	10 ... 14 mm	24	26.4	10	9 ... 16 mm	30	33.5	12	9 ... 18 mm	30	33.5	12	13 ... 18 mm	30	33.5	12	13 ... 20 mm	40	44	15	13 ... 25 mm	40	44	15	18 ... 25 mm	40	44	15	20 ... 26 mm	50	55	15	22 ... 32 mm	50	55	15	20 ... 32 mm	50	55	15	32 ... 38 mm	57	60	24
	Outer cable Ø	SW	E		Nm																																																											
	5 ... 9 mm	22	24.4		10																																																											
	5 ... 12 mm	22	24.4		10																																																											
	6 ... 12 mm	22	24.4		10																																																											
	10 ... 14 mm	24	26.4		10																																																											
	9 ... 16 mm	30	33.5		12																																																											
	9 ... 18 mm	30	33.5		12																																																											
	13 ... 18 mm	30	33.5		12																																																											
	13 ... 20 mm	40	44		15																																																											
	13 ... 25 mm	40	44		15																																																											
	18 ... 25 mm	40	44		15																																																											
	20 ... 26 mm	50	55		15																																																											
	22 ... 32 mm	50	55		15																																																											
	20 ... 32 mm	50	55		15																																																											
	32 ... 38 mm	57	60		24																																																											
	M20	5 ... 12	19 00 000 5081																																																													
M20	6 ... 12	19 00 000 5082																																																														
M20	10 ... 14	19 00 000 5084																																																														
M25	9 ... 16	19 00 000 5090																																																														
M25	9 ... 18	19 00 000 5091																																																														
M25	13 ... 18	19 00 000 5092																																																														
M32	13 ... 20	19 00 000 5094																																																														
M32	13 ... 25	19 00 000 5095																																																														
M32	18 ... 25	19 00 000 5096																																																														
M40	20 ... 26	19 00 000 5097																																																														
M40	20 ... 32	19 00 000 5099																																																														
M40	22 ... 32	19 00 000 5098																																																														
M50	32 ... 38	19 00 000 5086																																																														



Accessories

Identification	Size	Clamping range (mm)	Part number	Drawing (dimensions in mm)																																				
Han® CGM-M-Rail, Cable gland, Railway version, IP68	M20	7 ... 10	19 00 000 7120	 <table border="1"> <thead> <tr> <th>Outer cable ø</th> <th>SW</th> <th>E</th> <th>Nm</th> </tr> </thead> <tbody> <tr> <td>7 ... 10 mm</td> <td>22/24</td> <td>26.4</td> <td>6</td> </tr> <tr> <td>10 ... 14 mm</td> <td>22/24</td> <td>26.4</td> <td>6</td> </tr> <tr> <td>11 ... 14.5 mm</td> <td>27/30</td> <td>32.8</td> <td>7</td> </tr> <tr> <td>14.5 ... 18 mm</td> <td>27/30</td> <td>32.8</td> <td>7</td> </tr> <tr> <td>16 ... 20.5 mm</td> <td>36/40</td> <td>43.9</td> <td>8</td> </tr> <tr> <td>20.5 ... 35 mm</td> <td>36/40</td> <td>43.9</td> <td>8</td> </tr> <tr> <td>21 ... 26.5 mm</td> <td>46/50</td> <td>54.9</td> <td>8</td> </tr> <tr> <td>26.5 ... 32 mm</td> <td>46/50</td> <td>54.9</td> <td>8</td> </tr> </tbody> </table>	Outer cable ø	SW	E	Nm	7 ... 10 mm	22/24	26.4	6	10 ... 14 mm	22/24	26.4	6	11 ... 14.5 mm	27/30	32.8	7	14.5 ... 18 mm	27/30	32.8	7	16 ... 20.5 mm	36/40	43.9	8	20.5 ... 35 mm	36/40	43.9	8	21 ... 26.5 mm	46/50	54.9	8	26.5 ... 32 mm	46/50	54.9	8
	Outer cable ø	SW	E		Nm																																			
	7 ... 10 mm	22/24	26.4		6																																			
	10 ... 14 mm	22/24	26.4		6																																			
	11 ... 14.5 mm	27/30	32.8		7																																			
	14.5 ... 18 mm	27/30	32.8		7																																			
	16 ... 20.5 mm	36/40	43.9		8																																			
	20.5 ... 35 mm	36/40	43.9		8																																			
21 ... 26.5 mm	46/50	54.9	8																																					
26.5 ... 32 mm	46/50	54.9	8																																					
M20	10 ... 14	19 00 000 7121																																						
M25	11 ... 14.5	19 00 000 7122																																						
M25	14.5 ... 18	19 00 000 7123																																						
M32	16 ... 20.5	19 00 000 7124																																						
M32	20.5 ... 25	19 00 000 7125																																						
M40	21 ... 26.5	19 00 000 7126																																						
M40	26.5 ... 32	19 00 000 7127																																						

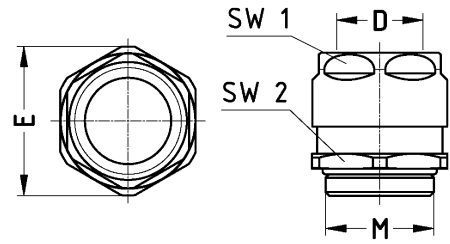

Outer cable ø	SW	E	Nm
7 ... 10 mm	22/24	26.4	6
10 ... 14 mm	22/24	26.4	6
11 ... 14.5 mm	27/30	32.8	7
14.5 ... 18 mm	27/30	32.8	7
16 ... 20.5 mm	36/40	43.9	8
20.5 ... 35 mm	36/40	43.9	8
21 ... 26.5 mm	46/50	54.9	8
26.5 ... 32 mm	46/50	54.9	8



## Technical characteristics

Degree of protection acc. to IEC IP68  
60529

## Technical characteristics

Material (cable glands)  
RoHS

Metal  
compliant with exemption

Identification	Size	Clamping range (mm)	Part number	Drawing (dimensions in mm)			
				Outer cable Ø	SW	E	Shielding Ø B
Cable gland, EMC version, IP68	M20	4 ... 6.5	19 62 000 5081	6.5 ... 9.5	22	24.4	3.5 ... 8.5
	M20	6.5 ... 9.5	19 62 000 5080	4 ... 6.5	22	24.4	2.5 ... 6.5
	M20	7 ... 10.5	19 62 000 5082	7 ... 10.5	22	24.4	6.5 ... 10.5
	M20	9 ... 13	19 62 000 5084	9 ... 13	22	24.4	6.5 ... 10.5
	M25	6.5 ... 9.5	19 62 000 5090	6.5 ... 9.5	22	31.2	3 ... 8
	M25	9 ... 13	19 62 000 5092	9 ... 13	28	31.2	4.8 ... 8
	M32	11.5 ... 15.5	19 62 000 5094	11.5 ... 15.5	35	38.5	8 ... 13.5
	M32	14 ... 18	19 62 000 5096	14 ... 18	35	38.5	9 ... 14.5
	M40	17 ... 20.5	19 62 000 5097	17 ... 20.5	43	47.3	15 ... 20
	M40	20 ... 25	19 62 000 5098	20 ... 25	43	47.3	15 ... 20

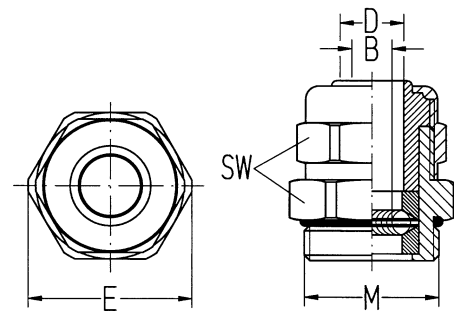







Accessories

## Technical characteristics

Material (accessories) Thermoplastic, Metal  
 Colour (accessories) Black

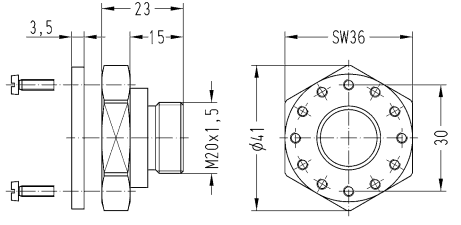
## Technical characteristics

RoHS compliant with exemption, compliant

Identification	Size	Reduced size	Part number	Drawing (dimensions in mm)
Han A <sup>®</sup> , Adapter, for motor connection 	M20		19 20 000 9962	 <p>① Han<sup>®</sup> 3 A                      ② Seal                      ③ Adapter Han<sup>®</sup> 3 A                      ④ Housing for motor application</p> 
Dummy plugs 	M32 M40		19 00 000 5172 19 00 000 5173	  <p>M32: Ø 35 mm                      M40: Ø 46.2 mm</p>
Reduced size 	M20 M32 M32	M16 M20 M25	19 00 000 5060 19 00 000 5067 19 00 000 5068	



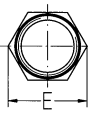

Identification	Size	Reduced size	Part number	Drawing (dimensions in mm)
Reduced size, With O-ring	M32 M32	M20 M25	19 00 000 5066 19 00 000 5069	
Dummy plugs, With O-ring	M20 M25 M32 M40		19 00 000 5070 19 00 000 5071 19 00 000 5072 19 00 000 5073	  <p>                         M20: SW 22; E 25.4                          M25: SW 28; E 32.3                          M32: SW 35; E 40.4                          M40: SW 44; E 50.8                     </p>





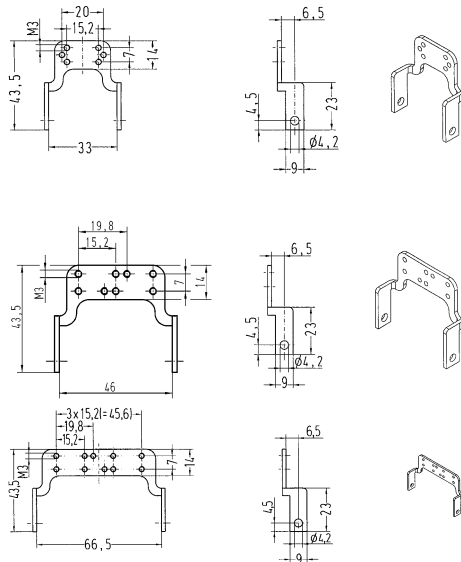

## Technical characteristics

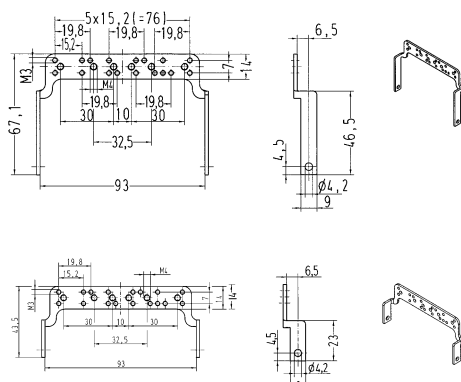
Material (accessories) Steel, zinc plated

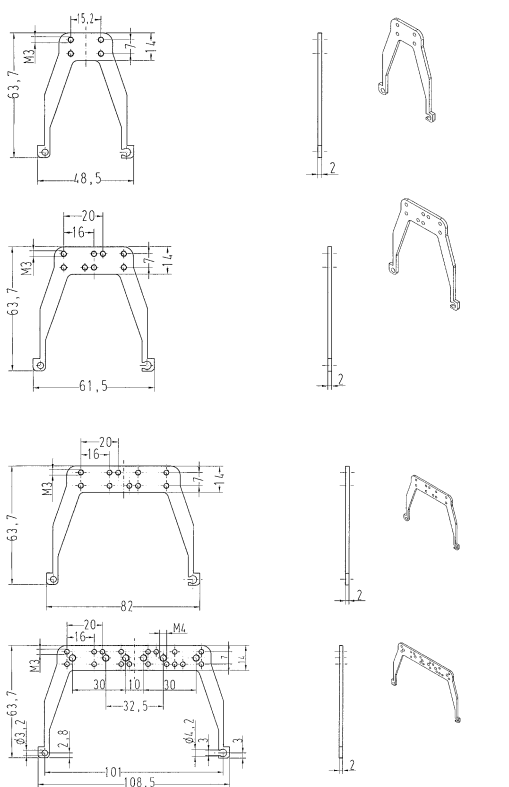
## Technical characteristics

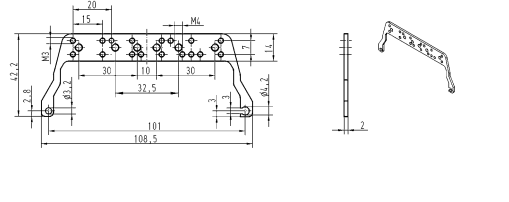
RoHS compliant

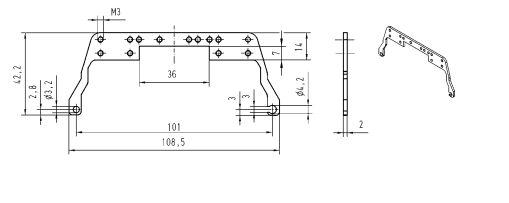
Identification	Size	Part number	Drawing (dimensions in mm)
<p>Han E®, Han® EE, Han DD®, Han-Snap®, Shielding frame, for bulkhead mounted housings, for hoods, high construction,</p> <p>Pack contents: Ground terminal frame with M4 screws for fixing at insert</p> 	<p>06 B 10 B 16 B</p>	<p>09 00 000 5206 09 00 000 5207 09 00 000 5208</p>	
<p>Han E®, Han® EE, Han DD®, Han-Snap®, Shielding frame, for bulkhead mounted housings, for hoods, high construction, 24 B,</p> <p>Pack contents: Ground terminal frame with M4 screws for fixing at insert</p> 	<p>24 B 24 B</p>	<p>09 00 000 5210 09 00 000 5280</p>	

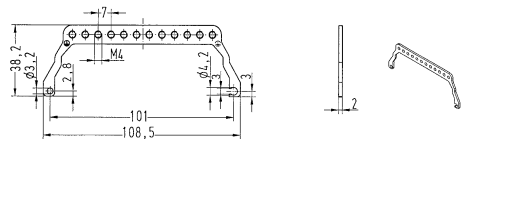
Identification	Size	Part number	Drawing (dimensions in mm)
<p>Han-Modular®, Shielding frame, for bulkhead mounted housings</p> 	<p>06 B 10 B 16 B 24 B L32 B</p>	<p>09 00 000 5256 09 00 000 5257 09 00 000 5258 09 00 000 5211 09 00 032 5201</p>	
<p>Han-Modular®, Shielding frame, for bulkhead mounted housings, for hoods, high construction</p> 	<p>24 B</p>	<p>09 00 000 5298</p>	
<p>Han-Quintax®, Shielding frame, for bulkhead mounted housings, for hoods, high construction</p> 	<p>24 B</p>	<p>09 00 000 5235</p>	
<p>Han-Modular®, PE bracket, for bulkhead mounted housings, for hoods, high construction</p> 	<p>24 B</p>	<p>09 00 000 5209</p>	

Accessories

Accessories

## Technical characteristics

## Technical characteristics

Material (accessories) Steel, zinc plated

RoHS compliant

Identification	Cable diameter (mm)	Part number	Drawing (dimensions in mm)
----------------	---------------------	-------------	----------------------------

Clamp, for shield frames



5  
10

09 00 000 5341  
09 00 000 5342

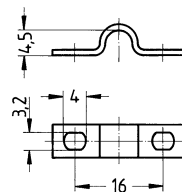

Cable diameter 5 mm

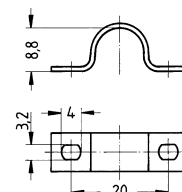



Cable diameter 10 mm

## Technical characteristics

Material (accessories)      Metal

## Technical characteristics

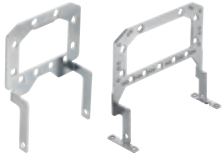
Surface (accessories)      Zinc plated  
RoHS                              compliant

Identification	Size	Part number	Drawing (dimensions in mm)
<p>Grip frame</p>  <p>Can only be used with screw adapter!</p>	<p>16 B 24 B</p>	<p>09 00 016 5603 09 00 024 5601</p>	
<p>Grip frame, With screw adapter and screw to use in connection with 09 00 000 5602</p> 	<p>16 B 24 B</p>	<p>09 00 016 5612 09 00 024 5611</p>	

Accessories

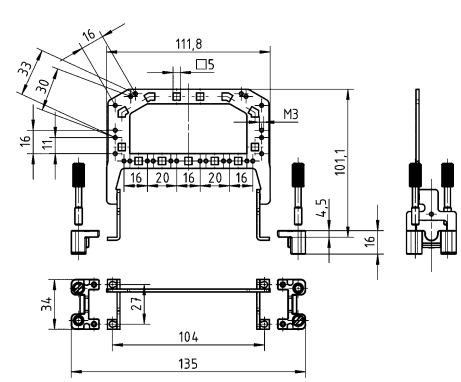
Identification	Size	Part number	Drawing (dimensions in mm)
<p>Han-Modular®, Grip frame, With screw adapter and screw to use in connection with 09 00 000 5602</p> 	<p>06 B 10 B 16 B 24 B</p>	<p>09 00 006 5605 09 00 010 5605 09 00 016 5605 09 00 024 5605</p>	

## Features

- Grip frame suitable for Han® 64 D / Han® 108 DD / Han® 24 E / Han® 24 ES / Han® 24 ESS / Han® 46 EE
- Multiple shield connections via grip frame
- Cable can be fixed with clamps or cable tie

## Technical characteristics

Material (accessories)	Zinc die-cast
Surface (accessories)	Copper-plated, Nickel plated compliant
RoHS	

### Identification

### Part number

### Drawing (dimensions in mm)

Screw adapter,  
Top part,  
With fixing screw

09 00 000 5601



Screw adapter,  
Bottom part

09 00 000 5602

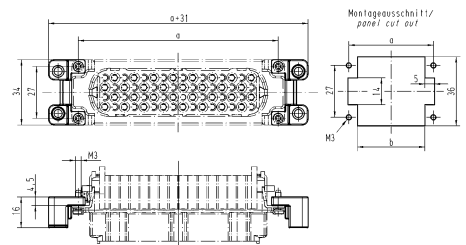

	a	b
6 B	44	35
10 B	57	48
16 B	77,5	68,5
24 B	104	95

Screw adapter,  
Bottom part,  
With fixing screw

09 00 000 5603

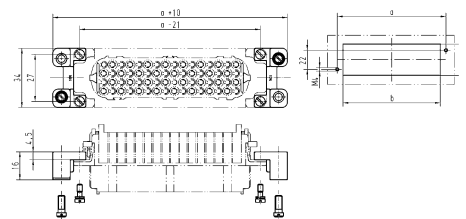

	a	b
6 B	65	52
10 B	78	65
16 B	98,5	85,5
24 B	125	112

## Features

- Use of standard inserts or Han-Modular® hinged frames
- Pre-assembled fixing brackets
- Simple and quick assembly
- 36 coding options

## Technical characteristics

Material (accessories)	Metal, Thermoplastic
Surface (accessories)	Zinc plated
RoHS	compliant with exemption

Identification	Size	Part number	Drawing (dimensions in mm)
Grip frame, with fixing brackets	06 B 10 B 16 B 24 B 32 B	09 00 006 5610 09 00 010 5610 09 00 016 5610 09 00 024 5610 09 00 032 5610	
Panel mounting parts, Pack contents: Supplied as a pair		09 00 000 5614	



## Features

- Guide pins and bushes for secure mating of hood and housing
- Can also be used for coding
- Are used in the hinged frame instead of M6 fixing screws





## Technical characteristics

Material (accessories)



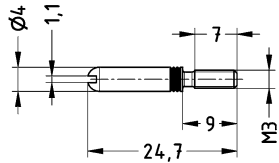
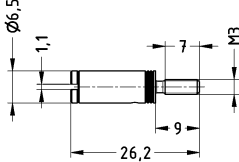
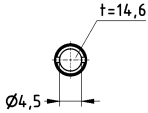

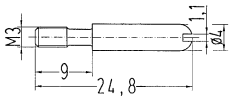
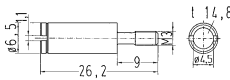

Steel, zinc plated, Stainless steel

RoHS

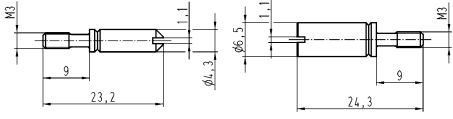
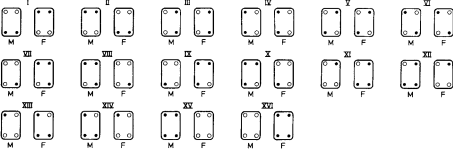
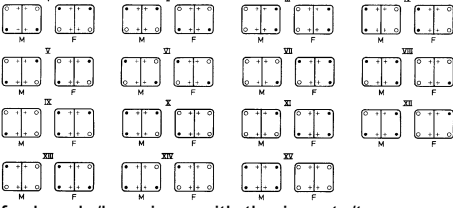
compliant with exemption, compliant

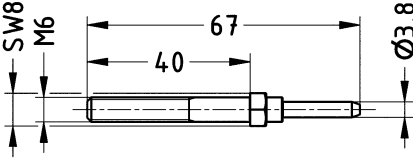
Identification	Part number		Drawing (dimensions in mm)
	Male	Female	
Coding, With guide pins/bushes, for application "insert with screw adapter" with/ without grip frame 	09 33 000 9808	09 33 000 9809	  
Coding, With guide pins/bushes, for application "insert in hood/housing" 	09 33 000 9908	09 33 000 9909	 
Han-Modular®, Coding, With guide pins/bushes, for application "insert with screw adapter" with/ without grip frame  Please order 4 pieces for one connector.	09 14 000 9981	09 14 000 9982	

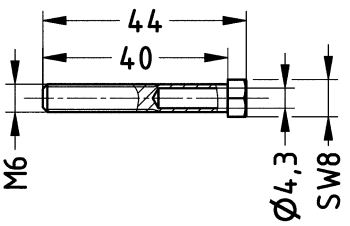
Accessories

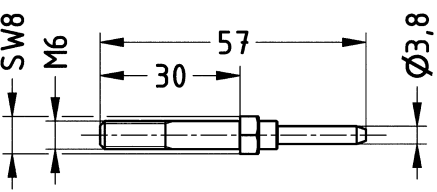
Identification	Part number		Drawing (dimensions in mm)
	Male	Female	
<p>Han-Modular®, Coding, With guide pins/bushes, for application "insert in hood/housing"</p>  <p>Please order 4 pieces for one connector.</p>	09 14 000 9908	09 14 000 9909	  <p>for hoods/housings with one insert/one frame</p>  <p>for hoods/housings with two inserts/two frames</p> <ul style="list-style-type: none"> <li>◆ Guide pin</li> <li>○ Guide bush</li> <li>+ Fixing screw</li> <li>M - male insert</li> <li>F - female insert</li> </ul>
<p>Han® HPR enlarged, Guide pin, for bulkhead mounted housings</p> 	09 40 000 9811		
<p>Han® HPR enlarged, Guide bush, for bulkhead mounted housings</p> 		09 40 000 9812	
<p>Han® HPR enlarged, Guide pin, for hoods</p> 	09 40 000 9906		

Identification	Part number		Drawing (dimensions in mm)
	Male	Female	
Han® HPR enlarged, Guide bush, for hoods		09 40 000 9907	

Accessories

Accessories

## Technical characteristics

Material (accessories) Steel, zinc plated

## Technical characteristics

RoHS compliant with exemption

Identification

Part number

Drawing (dimensions in mm)

Coding,  
With code pins,  
Han® B

09 30 000 9901

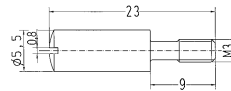

Please order 4 pieces for one connector.

Han-Modular®,  
Coding,  
With code pins

09 14 000 9901

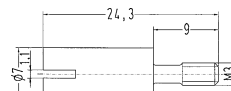

Please order 4 pieces for one connector.

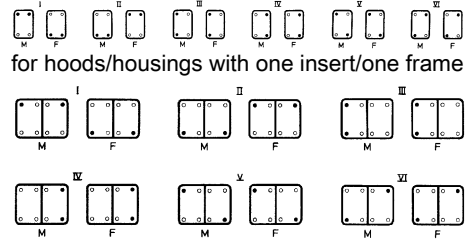

for hoods/housings with one insert/one frame

for hoods/housings with two inserts/two frames

- ◆ Code pin
- + Fixing screw
- M - male insert
- F - female insert

## Technical characteristics



Material (accessories)  
RoHS

Thermoplastic compliant, compliant with exemption

## Details

### Coding pin

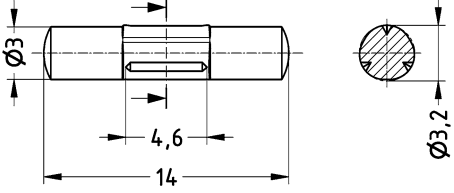
Use of the coding pin prevents incorrect mating to other connectors of the same type. The male pin should be omitted from the opposing cavity in the male insert.

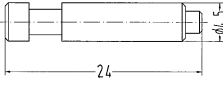
Identification	Part number Female	Drawing (dimensions in mm)
Han D <sup>®</sup> , Han DD <sup>®</sup> , Han <sup>®</sup> DDD, Coding pin    Only for crimp termination With loss of one contact	09 33 000 9915	
Han E <sup>®</sup> , Han <sup>®</sup> EE, Han <sup>®</sup> EEE, Coding pin    for crimp inserts only With loss of one contact	09 33 000 9954	



## Features

- Suitable for all inserts of the series Han E®, Han E® HMC, Han EE®, Han EE® HMC, Han EEE®, Han EEE® HMC, Han® ES, Han D® (size B), Han D® HMC, Han DD®, Han DD® HMC, Han-Com®, Han® HsB, Han-Modular®
- Due to the floating system of the docking frame the PE connection of the mounting base has to be installed separately.
- Inserts are protected against mechanical damage

## Technical characteristics

Mating cycles	≥500
Mating cycles with other HMC components	≥10000
Material (accessories)	Stainless steel
RoHS	compliant with exemption

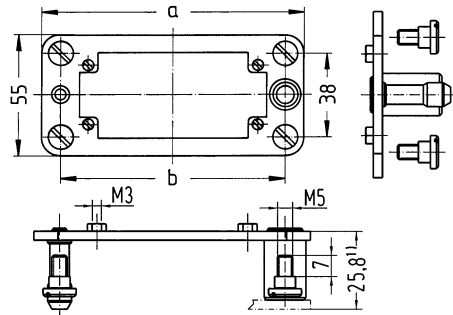
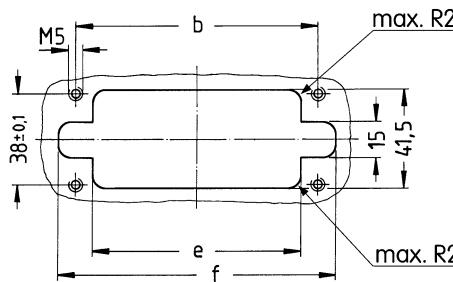
Identification	Size	Part number	Drawing (dimensions in mm)
Docking frame, Pack contents: 1 frame, 4 cheese head shoulder screws (Steel, zinc plated) to fix the docking frame  Pull-in-range x-axis: ± 1.5 mm Pull-in-range y-axis: ± 1.5 mm	06 B 10 B 16 B 24 B	09 30 006 1704 09 30 010 1704 09 30 016 1704 09 30 024 1704	 Distance for electrical and FO contacts max. 27 mm; for Han-Modular® series max. 26.5 mm 6 B: a=86; b=69 10 B: a=99; b=82 16 B: a= 119.5 ; b= 102.5 24 B: a=146; b=129  6 B: b= 69; e= 54.5; f= 84 10 B: b= 82; e= 67.5; f= 97 16 B: b= 102.5; e= 88; f= 117.5 24 B: b= 129; e= 114.5; f= 144

## Technical characteristics

Limiting temperature -40 ... +125 °C  
 Degree of protection acc. to IEC IP20  
 60529  
 Material (accessories) Thermoplastic  
 Material flammability class acc. to UL 94 V-0

## Specifications and approvals

DIN EN 45545-2 R22: HL1, HL2, HL3  
 DIN EN 45545-2 R23: HL1, HL2, HL3

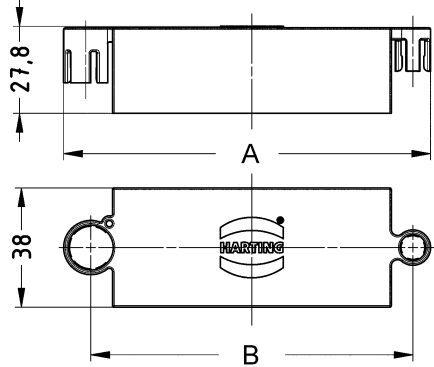
Identification	Size	Part number	Drawing (dimensions in mm)															
Protection cover, for Han® docking frame, IP20 	06 B	09 30 006 5418	 <table border="1" data-bbox="994 1294 1449 1444"> <thead> <tr> <th></th> <th>A</th> <th>B</th> </tr> </thead> <tbody> <tr> <td>6 B</td> <td>83.3 mm</td> <td>69 mm</td> </tr> <tr> <td>10 B</td> <td>96.3 mm</td> <td>82 mm</td> </tr> <tr> <td>16 B</td> <td>116.8 mm</td> <td>102.5 mm</td> </tr> <tr> <td>24 B</td> <td>143.3 mm</td> <td>129 mm</td> </tr> </tbody> </table>		A	B	6 B	83.3 mm	69 mm	10 B	96.3 mm	82 mm	16 B	116.8 mm	102.5 mm	24 B	143.3 mm	129 mm
		A		B														
	6 B	83.3 mm		69 mm														
	10 B	96.3 mm		82 mm														
	16 B	116.8 mm		102.5 mm														
24 B	143.3 mm	129 mm																
10 B	09 30 010 5418																	
16 B	09 30 016 5418																	
24 B	09 30 024 5418																	

Number of contacts

**3+**

Accessories

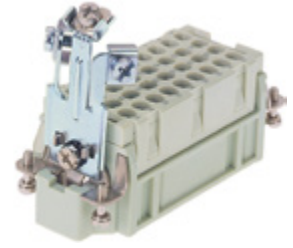

## Features

- 3 PE-terminations
- Screws with ± head
- Self lifting washer
- Suitable for use with all inserts of the Han® 6 B to 24 B size (except Han® ESS-inserts)
- Suitable in hoods high construction

## Technical characteristics

Number of contacts	3
Contact resistance	≤3 mΩ
Material (contacts)	Copper alloy
RoHS	compliant

## Details

The PE-multiple ground connection may be used to terminate three PE-wires on one connector. Each PE-wire can be terminated and removed separately.  
(acc. VDE 0113 EN 60204 Pt. 14.1.1)

Identification	Conductor cross-section (mm <sup>2</sup> )	Part number	Drawing (dimensions in mm)
PE Multiple ground connection, Pack contents: Distributor, Fixing screw M4 with washer Contact surface: Nickel plated	0.5 ... 2.5	09 33 000 9992	







## Technical characteristics

RoHS compliant

## Details

When using inserts without hoods or housings and requiring a strain relief this system is suitable for all rectangular connectors of series Han DD®, Han® 40-64 D, Han E®, Han® ES, Han Hv E®, Han® Hv ES, Han® EE, Han® K 8/24.

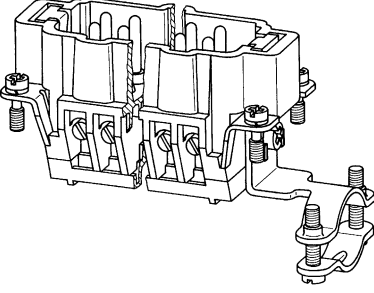
Fitted at the opposite end to the PE-termination.

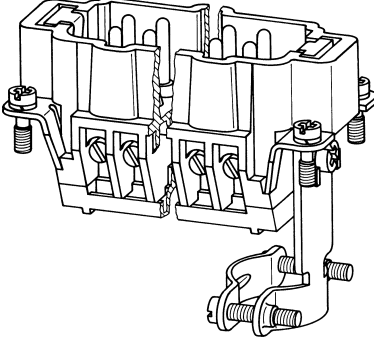
Identification	Clamping range (mm)	Part number	Drawing (dimensions in mm)
<p>Strain relief clamp, Angled, Pack contents: Strain relief clamp with 2 screws M3, Fixing screw M4 with washer</p> 	9 ... 19	09 00 000 5339	
<p>Strain relief clamp, Straight, Pack contents: Strain relief clamp with 2 screws M3, Fixing screw M4 with washer</p> 	9 ... 19	09 00 000 5340	

Accessories

## Features



- Useable for inserts without hoods or housings and requiring a strain relief
- Suitable for all rectangular connectors of the Han® series Han® 6 B, 10 B, 16 B, 24 B

## Technical characteristics

RoHS compliant with exemption

## Details

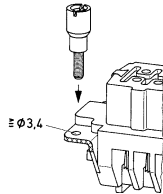
When using inserts without hoods or housings and requiring a locking facility this system is suitable for all rectangular connectors of the Han® series size 6 ... 24 B. For each connector we recommend two screw pins and two bushes as shown which are fitted diagonally to the inserts instead of the ordinary fixing screws. Holes for fixing to be drilled as shown.

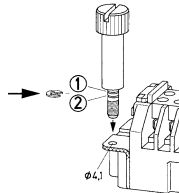
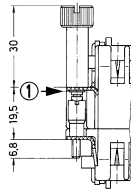
Identification		Part number	Drawing (dimensions in mm)
Bush		09 33 000 9912	
Order 2 pieces for one connector.			
Knurled screw		09 33 000 9910	
Order 2 pieces for one connector.			
			Mounting example

## Technical characteristics







Material (accessories)      Stainless steel



## Technical characteristics

RoHS      compliant, compliant with exemption

Identification	Size	Part number	Drawing (dimensions in mm)
Han-Modular® Compact, Fixing screws	ST 2.9x9.5 F-H	09 12 000 9921	
			
Fixing screws	M3	09 16 000 9903	
			
Fixing screws, With seal, Han® 3 A	M3	09 20 000 9918	
			
Fixing screws, Han® 3 A	M3	09 20 000 9995	
			
Toggle locking screw, Han® 6/10/16/24 HPR		09 40 000 9931	
			
Toggle locking screw, 3 HPR		09 40 000 9933	
			

Accessories

Identification	Size	Part number	Drawing (dimensions in mm)
Contact screw, Han A®    for PE in Han® Q 5/0, Q 7/0		09 30 000 9997	
PE screw, Han-Modular® hinged frames  	M3 M4	09 14 000 9953 09 14 000 9954	
PE screw, Han A®, Han® 15 D, Han® 25 D  	M3.5	09 20 000 9919	
PE screw  	M4	09 33 000 9925	
PE screw, Han-Com®, Han® HsB  	M5	09 33 000 9926	
Countersunk flat  		09 70 000 9902	
Countersunk flat, With seal  		09 70 000 9905	

Identification	Size	Part number	Drawing (dimensions in mm)
Locking screw, 3 HPR 	M4	09 40 000 9929	
Locking screw, Han® 6/10/16/24 HPR 	M6	09 40 000 9932	
Locking screw, 48 HPR 	M6	09 40 000 9937	

Accessories



Accessories

## Technical characteristics

Limiting temperature -40 ... +125 °C  
 Degree of protection acc. to IEC 60529 IP65

## Technical characteristics

Material (accessories) Steel, zinc plated, Thermoplastic, Metal  
 RoHS compliant, compliant with exemption

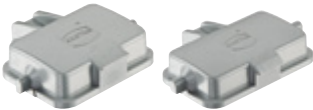



Identification	Size	Part number	Drawing (dimensions in mm)
Bearing pedestal, for Han® 10 A, 16 A, 32 A, 6 B, 10 B, 16 B, 24 B 		09 30 000 9964	
Han A®, Protection cover, for bearing pedestal, Thermoplastic, IP65 	10 A 16 A	09 20 010 5410 09 20 016 5410	
Han® B, Protection cover, for bearing pedestal, Metal, IP65 	06 B 10 B 16 B 24 B	09 30 006 5403 09 30 010 5404 09 30 016 5404 09 30 024 5404	
Han® B, Protection cover, for bearing pedestal, Thermoplastic, IP65 	06 B 10 B 16 B 24 B	09 30 006 5410 09 30 010 5410 09 30 016 5410 09 30 024 5410	

Technical characteristics



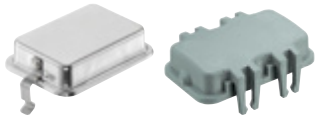
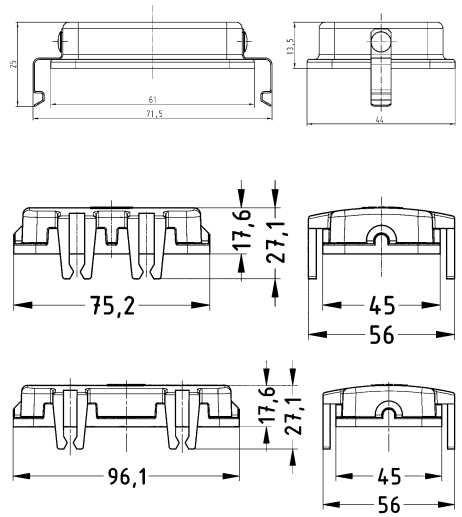

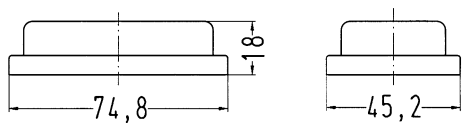

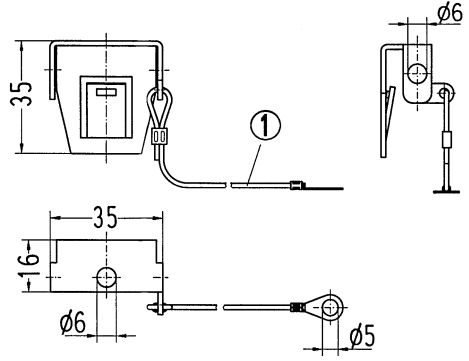

Material (accessories) Metal, Thermoplastic

Technical characteristics

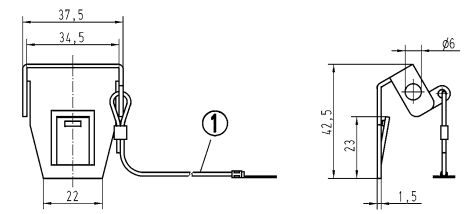
RoHS compliant

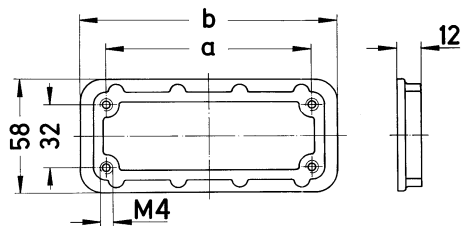
Identification	Size	Part number	Drawing (dimensions in mm)
<p>Han® B, Dust protection cover, for hoods, With board locks</p> 	<p>06 B 10 B 16 B</p>	<p>09 30 006 5401 09 30 010 5401 09 30 016 5401</p>	
<p>Han® B, Dust protection cover, for housings</p> 	<p>10 B 16 B 24 B</p>	<p>09 30 010 5406 09 30 016 5406 09 30 024 5406</p>	
<p>Han® HPR, Dust protection cover, for housings</p> 	<p>03 HPR 06 HPR 10 HPR 16 HPR 24 HPR</p>	<p>09 40 003 5406 09 40 006 5406 09 40 010 5406 09 40 016 5406 09 40 024 5406</p>	

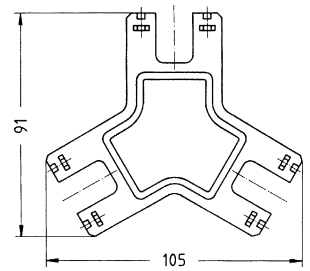
Accessories

Identification	Size	Part number	Drawing (dimensions in mm)
<p>Locking element, With cord, for Han® 10/16/24 B housings bulkhead mounting with Han-Easy Lock® double levers</p> 		09 30 000 9986	 <p>① Length 120 mm</p>
<p>Locking element, With cord, for Han® 10/16/24 B with double metal levers</p> 		09 30 000 9987	 <p>① Length 120 mm</p>
<p>Mounting frames, for standard hoods/housings</p> 	06 B 10 B 16 B 24 B	09 40 000 9921 09 40 000 9922 09 40 000 9923 09 40 000 9924	 <p>6 B: a=70; b=96 10 B: a=83; b=109 16 B: a=103; b=129 24 B: a=130; b=156</p>
<p>Frame, for custom test adapters, Pack contents: 2 assembly plates, 12 nuts for insertion</p> 		09 38 000 9901	
<p>Label, According to CSA-approval, Pack contents: 50 labels per sheet</p> 		09 30 000 9958	



Identification	Size	Part number	Drawing (dimensions in mm)
<p>Contact lubricant DvDA, for Han® contacts, Pack contents: Vaporizer (40 ml), Handling instruction</p>  <p>Applicable onto Han® contacts to reduce mating and unmating forces. Content: Preperation of perfluorpolyethers</p>		09 99 000 0829	

Accessories