

Number of contacts

2+

40 A 400 V 6 kV 3

Han-Power

Identification

Han-Power® T,
Energy distributor,
With 3x Han® Q 2/0,
In Han® 3 A Housings, bulkhead mounting



Part number

09 12 008 4752

Drawing
(dimensions in mm)

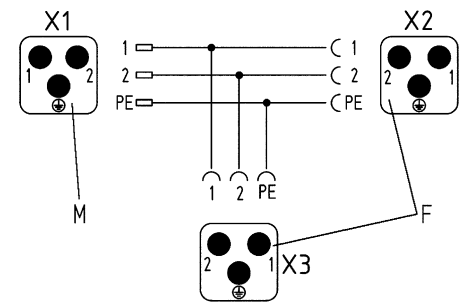
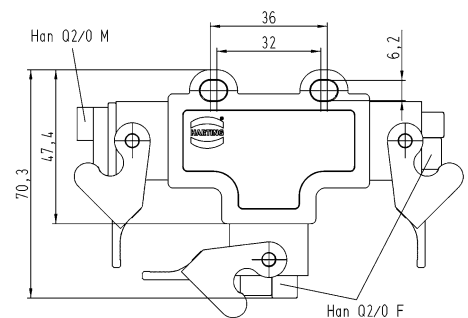

Wiring diagram