

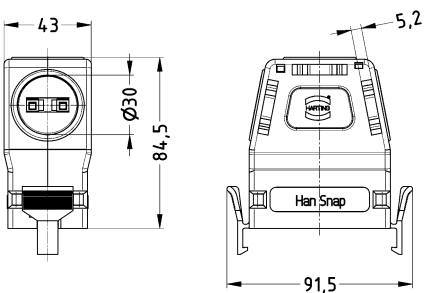

Snap-in latches

Han-Snap

Identification	Part number	Drawing (dimensions in mm)
<p>Han-Snap®, Shell housing, Top/side entry, Pack contents: 2 half shells with blind plugs</p> 	<p>09 33 010 0401</p>	
<p>Han-Snap®, Protection cover, Thermoplastic</p> 	<p>09 33 010 5401</p>	